

INSTALLATION, OPERATION &  
MAINTENANCE MANUAL  
FOR  
SERIES 500  
FP-HD END SUCTION FIRE  
PROTECTION PUMP

04 OCTOBER 2004  
Copyright © 2004 American-Marsh Pumps

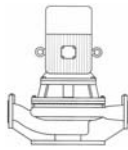
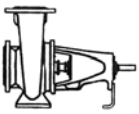

## CONTENTS

Page #

<b>SAFETY CONSIDERATIONS .....</b>	<b>4</b>
DANGER .....	4
WARNING .....	4
CAUTION.....	4
<b>PUMP IDENTIFICATION .....</b>	<b>5</b>
MANUFACTURER .....	5
TYPE OF PUMP .....	5
DATE OF MANUFACTURE .....	5
INSTALLATION, OPERATION & MAINTENANCE MANUAL IDENTIFICATION .....	5
NAMEPLATE INFORMATION.....	5
<b>WARRANTY .....</b>	<b>6</b>
<b>GENERAL INSTRUCTIONS.....</b>	<b>6</b>
<b>HANDLING AND TRANSPORT .....</b>	<b>6</b>
METHOD OF TRANSPORT .....	6
INSTALLATION .....	6
<b>STORAGE.....</b>	<b>6</b>
SHORT-TERM STORAGE .....	6
LONG-TERM STORAGE.....	7
<b>INSTALLATION &amp; ALIGNMENT .....</b>	<b>7</b>
FACTORY PRELIMINARY ALIGNMENT PROCEDURE.....	7
RECOMMENDED PROCEDURE FOR BASE PLATE INSTALLATION & FINAL FIELD ALIGNMENT .....	8
NEW GROUTED BASE PLATES .....	8
EXISTING GROUTED BASE PLATES.....	9
PIPING CONNECTION – SUCTION & DISCHARGE .....	9
SUCTION PIPING.....	9
DISCHARGE PIPING .....	10
PUMP AND SHAFT ALIGNMENT CHECK.....	10
IMPELLER CLEARANCES.....	10
REC & REI MOTOR ASSEMBLY .....	10
MECHANICAL SEAL .....	10
PACKING.....	11
PIPING CONNECTION –SEAL/PACKING SUPPORT SYSTEM .....	11
BEARING LUBRICATION .....	11
OIL LUBRICATED BEARINGS.....	11
DRIVER BEARINGS.....	12
COUPLING .....	12
<b>PUMP OPERATION .....</b>	<b>12</b>
ROTATION CHECK.....	12
PRE START-UP CHECKS.....	12
ENSURING PROPER NPSH <sub>A</sub> .....	12
MINIMUM FLOW .....	13
STARTING THE PUMP AND ADJUSTING FLOW .....	13
OPERATION IN SUB-FREEZING CONDITIONS.....	14
SHUTDOWN CONSIDERATIONS .....	14
TROUBLESHOOTING .....	14

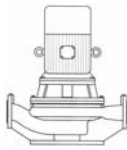
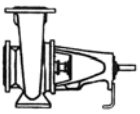

<b>MAINTENANCE</b> .....	<b>19</b>
PREVENTIVE MAINTENANCE.....	19
NEED FOR MAINTENANCE RECORDS .....	19
NEED FOR CLEANLINESS.....	19
DISASSEMBLY .....	19
FP-REF MODELS.....	19
FP-REI MODELS.....	20
CLEANING/INSPECTION .....	22
ASSEMBLY .....	22
FP-REF POWER FRAME ASSEMBLY .....	23
BEARING INSTALLATION .....	23
LIP SEALS.....	24
LABYRINTH SEALS.....	24
MAGNETIC SEALS .....	24
FP-REF WET END ASSEMBLY .....	25
INTERNAL COMPONENT MECHANICAL SEALS (STANDARD).....	25
CARTRIDGE MECHANICAL SEALS .....	25
EXTERNAL COMPONENT TYPE MECHANICAL SEAL .....	25
PACKING WITH SPLIT GLAND.....	25
PACKING WITH ONE PIECE GLAND .....	25
BEARING LUBRICATION.....	26
FP-REI FLUID ASSEMBLY .....	27
FP-REI SHAFT AND BRACKET ASSEMBLY.....	27
PUMP REINSTALLATION.....	27
<b>SPARE PARTS</b> .....	<b>27</b>
RECOMMENDED SPARE PARTS – STANDARD FP-REF & FP-REI PUMP .....	27
HOW TO ORDER SPARE PARTS .....	27
<b>APPENDIX A</b> .....	<b>30</b>
CRITICAL MEASUREMENTS AND TOLERANCES FOR MAXIMIZING MTBPM .....	30
PARAMETERS THAT SHOULD BE CHECKED BY USERS.....	30
ADDITIONAL PARAMETERS CHECKS BY AMERICAN-MARSH .....	30
IMPELLER BALANCING .....	30
POWER END ASSEMBLY .....	30
SEAL CHAMBER.....	31
COMPLETE PUMP.....	31
SPECIAL PARAMETERS CHECKED BY AMERICAN-MASH .....	32
SHAFT – MAXIMUM ROUGHNESS AT SEAL CHAMBER .....	32
BEARING HOUSING – BORE CONCENTRICITY.....	32
COMPLETE PUMP – DYNAMIC SHAFT DEFLECTION .....	32
<b>APPENDIX B</b> .....	<b>33</b>
AMERICAN-MARSH FP-REF MAINTENANCE INSTRUCTIONS BEARING HOUSING OIL SEALS (LABYRINTH TYPE) INPRO/SEAL® VBXX BEARING ISOLATORS .....	33

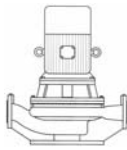
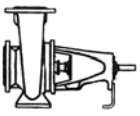

## SAFETY CONSIDERATIONS

The American-Marsh FP-REF & FP-REI end suction pumps have been designed and manufactured for safe operation. In order to ensure safe operation, it is very important that this manual be read in its entirety prior to installing or operating the pump. American-Marsh Pumps shall not be liable for physical injury, damage or delays caused by a failure to observe the instructions for installation, operation and maintenance contained in this manual.

Remember that every pump has the potential to be dangerous, because of the following factors:

- parts are rotating at high speeds
- high pressures may be present
- high temperatures may be present
- highly corrosive and/or toxic chemicals may be present

Paying constant attention to safety is always extremely important. However, there are often situations that require special attention. These situations are indicated throughout this book by the following symbols:



**DANGER** - Immediate hazards which WILL result in severe personal injury or death.



**WARNING** – Hazards or unsafe practices which COULD result in severe personal injury or death.



**CAUTION** – Hazards or unsafe practices which COULD result in minor personal injury or product or property damage.

Maximum Lifting Speed: 15 feet/second.

If in a climate where the fluid in the casing could freeze, never leave liquid in the pump casing. Drain the casing

completely. During winter months and cold weather, the liquid could freeze and damage the pump casing.

Do not run the equipment dry or start the pump without the proper prime (casing flooded).

Never operate the pump for more than a short interval with the discharge valve closed. The length of the interval depends on several factors including the nature of the fluid pumped and its temperature. Contact American-Marsh Engineering for additional support if required.

Never operate the pump with a closed suction valve.

Excessive pump noise or vibration may indicate a dangerous operating condition. The pump must be shutdown immediately.

Do not operate the pump for an extended period of time below the recommended minimum flow. See Figure 6, page 13.

The pump shaft MUST turn clockwise when viewed from the motor end. It is absolutely essential that the rotation of the motor be checked before installation of the coupling spacer and starting the pump. Incorrect rotation of the pump for even a short period of time can unscrew the impeller nut, which can cause severe damage.

If the liquid is hazardous, take all necessary precautions to avoid damage and injury before emptying the pump casing.

Residual liquid may be found in the pump casing, head and suction line. Take the necessary precautions if the liquid is hazardous, flammable, corrosive, poisonous, infected, etc.

Always lockout power to the driver before performing pump maintenance.

Never operate the pump without the coupling guard and all other safety devices correctly installed.

Do not apply heat to disassemble the pump or to remove the impeller. Entrapped liquid could cause an explosion.

If any external leaks are found while pumping hazardous product, immediately stop operations and repair.

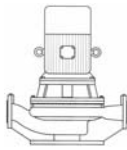
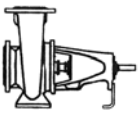

## PUMP IDENTIFICATION

### MANUFACTURER

American-Marsh Pumps  
185 Progress Road  
Collierville, TN 38017  
United States of America

### TYPE OF PUMP

The American-Marsh FP-REF & FP-REI end suction pumps are end suction, single stage centrifugal pumps. FP-REF pumps are of the flex-coupled, center-line

discharge type. The FP-REI pumps are of the close-coupled, inline discharge type

### DATE OF MANUFACTURE

The date of manufacture is indicated on the pump data plate.

### INSTALLATION, OPERATION & MAINTENANCE MANUAL IDENTIFICATION

Prepared: October, 2004  
Revision:

Edition: 01  
Date of Revision:

## NAMEPLATE INFORMATION

**AMERICAN-MARSH PUMPS**  
185 PROGRESS ROAD  
COLLIERVILLE, TN 38017

○ SERIAL NO

SIZE  TYPE

RPM  GPM  TDH

FIGURE 1 – Pump Data Plate

- SERIAL NUMBER : Serial Number of pump unit (issued by Production Control).
- SIZE : Size designation of pump (3x4-10)
- TYPE : Pump type (FP-REF or FP-REI).
- RPM : Speed of pump.
- GPM : Rated capacity of pump.
- TDH : Rated Total Dynamic Head of pump.

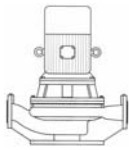
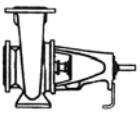

## WARRANTY

American-Marsh Pumps guarantees that only high quality materials are used in the construction of our pumps and that machining and assembly are carried out to high standards.

The pumps are guaranteed against defective materials and/or faulty craftsmanship for a period of one year from the date of shipment unless specifically stated otherwise.

Replacement of parts or of the pump itself can only be carried out after careful examination of the pump by qualified personnel.

**The warranty is not valid if third parties have tampered with the pump.**

This warranty does not cover parts subject to deterioration or wear and tear (mechanical seals, pressure and vacuum gauges, rubber or plastic items, bearings, etc.) or damage caused by misuse or improper handling of the pump by the end user.

Parts replaced under warranty become the property of American-Marsh Pumps.

Contact the American-Marsh Pumps' factory:

**American-Marsh Pumps**  
185 Progress Road  
Collierville, TN 38017  
United States Of America

**Phone:** (901) 860-2300  
**Fax:** (901) 860-2323  
**www.american-marsh.com**

## GENERAL INSTRUCTIONS

The pump and motor unit must be examined upon arrival to ascertain any damage caused during shipment. If damaged immediately notify the carrier and/or the sender. Check that the goods correspond exactly to the description on the shipping documents and report any differences as soon as possible to the sender. Always quote the pump type and serial number stamped on the data plate.

**The pumps must be used only for applications for which the manufacturers have specified:**

- ❖ **The construction materials**
- ❖ **The operating conditions (flow, pressure, temperature, etc.)**
- ❖ **The field of application**

In case of doubt, contact the manufacturer.

## HANDLING AND TRANSPORT

### **METHOD OF TRANSPORT**

The pump must be transported in the horizontal position

### **INSTALLATION**

During installation and maintenance, all components must be handled and transported securely by using suitable slings. Handling must be carried out by specialized personnel to avoid damage to the pump and persons. The lifting rings attached to various components should be used exclusively to lift the components for which they have been supplied.

**CAUTION**

**Maximum lifting speed: 15 feet/second**

## STORAGE

### **SHORT-TERM STORAGE**

Normal packaging is designed to protect the pump during shipment and for dry, indoor storage for up to two months or less. The procedure followed for this short-term storage is summarized below:

Standard Protection for Shipment :

- a. Loose unmounted items, including, but not limited to, oilers, packing, coupling spacers, stilts, and mechanical seals are packaged in a water proof plastic bag and placed under the coupling guard. Larger items are cartoned and metal banded to the base plate. For pumps not mounted on a base plate, the bag and/or carton is placed inside the shipping carton. All parts bags and cartons are identified with the American-Marsh sales order number, the customer purchase order number, and the pump item number (if applicable).
- b. Inner surfaces of the bearing housing, shaft (area through bearing housing), and bearings are coated with Cortec VCI-329 rust inhibitor, or equal.  
**Note: Bearing housings are not filled with oil prior to shipment.**
- c. Regreasable bearings are packed with grease (Royal Purple NLGI#2).
- d. After a performance test, if required, the pump is tipped on the suction flange for drainage (some residual water may remain in the casing). Then, internal surfaces of ferrous casings, covers,

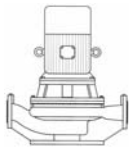
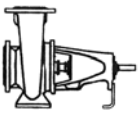

flange faces, and the impeller surface are sprayed with Calgon Vestal Labs RP-743m, or equal. Exposed shafts are taped with Polywrap.

- e. Flange faces are protected with plastic covers secured with plastic drive bolts. 3/16 in (7.8 mm) steel or 1/4 in (6.3 mm) wood covers with rubber gaskets, steel bolts, and nuts are available at extra cost.
- f. All assemblies are bolted to a wood skid which confines the assembly within the perimeter of the skid.
- g. Assemblies with special paint are protected with a plastic wrap.
- h. Group 1 and Group 2 bare pumps, when not mounted on base plates, are packed in hard paper cartons mounted on wood skids.
- i. Group 3 bare pumps, when not mounted on base plates, are bolted to wood skids.
- j. All pump assemblies utilizing polycrystalline base plates are mounted on wood skids.
- k. All assemblies having external piping (seal flush and cooling water plans), etc. are packaged and braced to withstand normal handling during shipment. In some cases components may be disassembled for shipment. The pump must be stored in a covered, dry location.

### **LONG-TERM STORAGE**

Long-term storage is defined as more than two months, but less than 12 months. The procedure American-Marsh follows for long-term storage of pumps is given below. These procedures are in addition to the short-term procedure.

Solid wood skids are utilized. Holes are drilled in the skid to accommodate the anchor bolt holes in the base plate, or the casing and bearing housing feet holes on assemblies less base plate. Tackwrap sheeting is then placed on top of the skid and the pump assembly is placed on top of the Tackwrap. Metal bolts with washers and rubber bushings are inserted through the skid, the Tackwrap, and the assembly from the bottom of the skid and are then secured with hex nuts. When the nuts are “snugged” down to the top of the base plate or casing and bearing housing feet, the rubber bushing is expanded, sealing the hole from the atmosphere. Desiccant bags are placed on the Tackwrap. The Tackwrap is drawn up around the assembly and hermetically (heat) sealed across the top. The assembly is completely sealed from the atmosphere and the desiccant will absorb any entrapped moisture. A solid wood box is then used to cover the assembly to provide protection from the elements and handling. This packaging will provide protection up to twelve months without damage to mechanical seals, bearings, lip seals, etc. due to humidity, salt laden air, dust, etc. After unpacking, protection will be the responsibility of the ENGINEERED PROCESS GROUP

user. Addition of oil to the bearing housing will remove the inhibitor. If units are to be idle for extended periods after addition of lubricants, inhibitor oils and greases should be used.

**Every three months, the shaft should be rotated approximately 10 revolutions.**

## **INSTALLATION & ALIGNMENT**

### **FACTORY PRELIMINARY ALIGNMENT PROCEDURE**

The purpose of factory alignment is to ensure that the user will have full utilization of the clearance in the motor holes for final job-site alignment. To achieve this, the factory alignment procedure specifies that the pump be aligned in the horizontal plane to the motor, with the motor foot bolts centered in the motor holes. This procedure ensures that there is sufficient clearance in the motor holes for the customer to field align the motor to the pump, to zero tolerance. This philosophy requires that the customer be able to place the base in the same condition as the factory. Thus the factory alignment will be done with the base sitting in an unrestrained condition on a flat and level surface. This standard also emphasizes the need to ensure the shaft spacing is adequate to accept the specified coupling spacer. The factory alignment procedure is summarized below:

1. The base plate is placed on a flat and level work bench in a free and unstressed position.
2. The base plate is leveled as necessary. Leveling is accomplished by placing shims under the rails (or, feet) of the base at the appropriate anchor bolt hole locations. Levelness is checked in both the longitudinal and lateral directions.
3. The motor and appropriate motor mounting hardware is placed on the base plate and the motor is checked for any planar soft-foot condition. If any is present it is eliminated by shimming.
4. The motor feet holes are centered around the motor mounting fasteners.
5. The motor is fastened in place by tightening the nuts on two diagonal motor mounting studs.
6. The pump is put onto the base plate and leveled. The foot piece under the bearing housing is adjustable. It is used to level the pump, if necessary. If an adjustment is necessary, we add or delete shims (#109A) between the foot piece and the bearing housing.
7. The spacer coupling gap is verified.

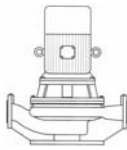
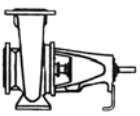

8. The parallel and angular *vertical* alignment is made by shimming under the motor.
9. All four motor feet are tightened down.
10. The pump and motor shafts are then aligned *horizontally*, both parallel and angular, by *moving the pump* to the fixed motor. The pump feet are tightened down.
11. Both horizontal and vertical alignment are again final checked as is the coupling spacer gap.

## RECOMMENDED PROCEDURE FOR BASE PLATE INSTALLATION & FINAL FIELD ALIGNMENT

### NEW GROUDED BASE PLATES

1. The pump foundation should be located as close to the source of the fluid to be pumped as practical. There should be adequate space for workers to install, operate, and maintain the pump. The foundation should be sufficient to absorb any vibration and should provide a rigid support for the pump and motor. Recommended mass of a concrete foundation should be three times that of the pump, motor and base. Note that foundation bolts are imbedded in the concrete inside a sleeve to allow some movement of the bolt.
2. Level the pump base plate assembly. If the base plate has machined coplanar mounting surfaces, these machined surfaces are to be referenced when leveling the base plate. This may require that the pump and motor be removed from the base plate in order to reference the machined faces. If the base plate is without machined coplanar mounting surfaces, the pump and motor are to be left on the base plate. The proper surfaces to reference when leveling the pump base plate assembly are the pump suction and discharge flanges. **DO NOT** stress the base plate. Do not bolt the suction or discharge flanges of the pump to the piping until the base plate foundation is completely installed. If equipped, use leveling jackscrews to level the base plate. If jackscrews are not provided, shims and wedges should be used (see Figure 2). Check for levelness in both the longitudinal and lateral directions. Shims should be placed at all base anchor bolt locations, and in the middle edge of the base if the base is more than five feet long. Do not rely on the bottom of the base plate to be flat. Standard base plate bottoms are not machined, and it

is not likely that the field mounting surface is flat.

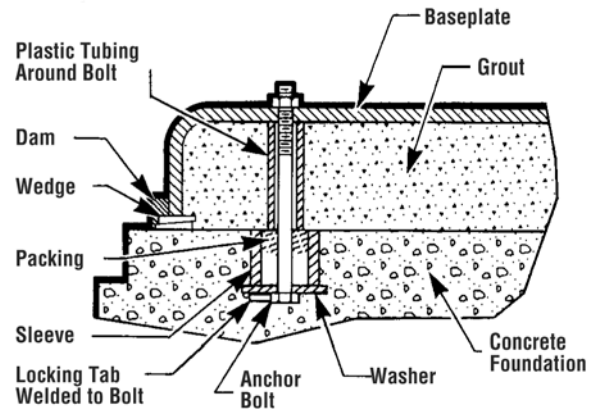
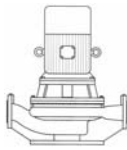
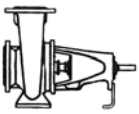

FIGURE 2 – Base Plate Foundation

3. After leveling the base plate, tighten the anchor bolts. If shims were used, make sure that the base plate was shimmed near each anchor bolt before tightening. Failure to do this may result in a twist of the base plate, which could make it impossible to obtain final alignment. Check the level of the base plate to make sure that tightening the anchor bolts did not disturb the level of the base plate. If the anchor bolts did change the level, adjust the jackscrews or shims as needed to level the base plate. Continue adjusting the jackscrews or shims and tightening the anchor bolts until the base plate is level.
4. Check initial alignment. If the pump and motor were removed from the base plate proceed with step 5 first, then the pump and motor should be reinstalled onto the base plate using American-Marsh's Factory Preliminary Alignment Procedure, and then continue with the following. As described above, pumps are given a preliminary alignment at the factory. This preliminary alignment is done in a way that ensures that, if the installer duplicates the factory conditions, there will be sufficient clearance between the motor hold down bolts and motor foot holes to move the motor into final alignment. If the pump and motor were properly reinstalled to the base plate or if they were not removed from the base plate and there has been no transit damage, and also if the above steps were done properly, the pump and driver should be within 0.015 in (0.38 mm) FIM (Full Indicator Movement) parallel, and 0.0025 in/in (0.0025 mm/mm) FIM angular. If this is not the case first





check to see if the driver mounting fasteners are centered in the driver feet holes. If not, recenter the fasteners and perform a preliminary alignment to the above tolerances by shimming under the motor for vertical alignment, and by moving the pump for horizontal alignment.

5. Grout the base plate. A non-shrinking grout should be used. Make sure that the grout fills the area under the base plate. After the grout has cured, check for voids and repair them. Jackscrews, shims and wedges should be removed from under the base plate at this time. If they were to be left in place, they could rust, swell, and cause distortion in the base plate.
6. Run piping to the suction and discharge of the pump. There should be no piping loads transmitted to the pump after connection is made. Recheck the alignment to verify that there are no significant loads.
7. Perform final alignment. Check for soft-foot under the driver. An indicator placed on the coupling, reading in the vertical direction, should not indicate more than 0.002 in (0.05 mm) movement when any driver fastener is loosened. Align the driver first in the vertical direction by shimming underneath its feet. When satisfactory alignment is obtained the number of shims in the pack should be minimized. It is recommended that no more than five shims be used under any foot. Final horizontal alignment is made by moving the driver. Maximum pump reliability is obtained by having near perfect alignment. American-Marsh recommends no more than 0.002 in (0.05mm) parallel, and 0.0005 in/in (0.0005 mm/mm) angular misalignment.
8. Operate the pump for at least an hour or until it reaches final operating temperature. Shut the pump down and recheck alignment while the pump is hot. Piping thermal expansion may change the alignment. Realign pump as necessary.

#### EXISTING GROUDED BASE PLATES

When a pump is being installed on an existing grouted base plate, the procedure is somewhat different from the previous section "New Grouted Base Plates."

1. Mount the pump on the existing base plate.
2. Level the pump by putting a level on the discharge flange. If not level, add or delete shims (#109A) between the foot piece and the bearing housing.
3. Check initial alignment. (Step 4 above)

#### ENGINEERED PROCESS GROUP

4. Run piping to the suction and discharge flanges of the pump. (Step 6 above)
5. Perform final alignment. (Step 7 above)
6. Recheck alignment after pump is hot. (Step 8 above)

All piping must be independently supported, accurately aligned and preferably connected to the pump by a short length of flexible piping. The pump should not have to support the weight of the pipe or compensate for misalignment. It should be possible to install suction and discharge bolts through mating flanges without pulling or prying either of the flanges. All piping must be tight. Pumps may air-bind if air is allowed to leak into the piping. If the pump flange(s) have tapped holes, select flange fasteners with thread engagement at least equal to the fastener diameter but that do not bottom out in the tapped holes before the joint is tight.

#### **PIPING CONNECTION – SUCTION & DISCHARGE**

All piping must be independently supported, accurately aligned and preferably connected to the pump by a short length of flexible piping. The pump should not have to support the weight of the pipe or compensate for misalignment. It should be possible to install suction and discharge bolts through mating flanges without pulling or prying either of the flanges. All piping must be tight. Pumps may air-bind if air is allowed to leak into the piping. If the pump flange(s) have tapped holes, select flange fasteners with thread engagement at least equal to the fastener diameter but that do not bottom out in the tapped holes before the joint is tight.



**Piping Forces:** Take care during installation and operation to minimize pipe forces and/or moments on the pump casing.

#### SUCTION PIPING

To avoid NPSH and suction problems, suction pipe sizes must be at least as large as the pump suction connection. **Never** use pipe or fittings on the suction that are smaller in diameter than the pump suction size. Figure 3 illustrates the ideal piping configuration with a minimum of 10 pipe diameters between the source and the pump suction. In most cases, horizontal reducers should be eccentric and mounted with the flat side up as shown in figure 6 with a maximum of one pipe size reduction. Never mount eccentric reducers with the flat side down. Horizontally mounted concentric reducers should not be used if there is any possibility of entrained air in the process fluid. Vertically mounted concentric

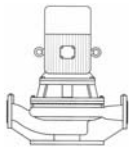
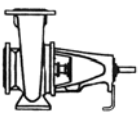

reducers are acceptable. In applications where the fluid is completely deaerated and free of any vapor or suspended solids, concentric reducers are preferable to eccentric reducers.

Avoid the use of throttling valves and strainers in the suction line. Start up strainers must be removed shortly after start up. When the pump is installed below the source of supply, a valve should be installed in the suction line to isolate the pump and to permit pump inspection and maintenance. However, never place a valve directly on the suction nozzle of the pump.

Refer to the American-Marsh Pump Engineering Manual and the Centrifugal Pump IOM Section of the Hydraulic Institute Standards for additional recommendations on suction piping.

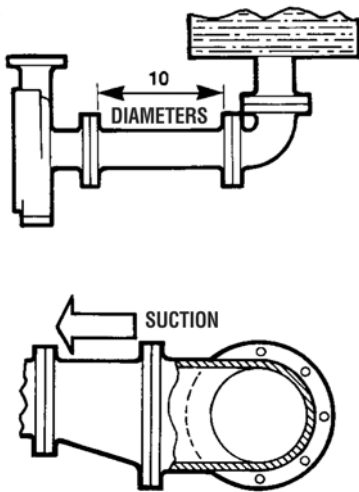

**FIGURE 3 – Good Piping Practices**

**DISCHARGE PIPING**

Install a valve in the discharge line. This valve is required for regulating flow and/or to isolate the pump for inspection and maintenance.

**! WARNING**

*When fluid velocity in the pipe is high, for example, 10 ft/s (3 m/s) or higher, a rapidly closing discharge valve can cause a damaging pressure surge. A dampening arrangement should be provided in the piping.*

**PUMP AND SHAFT ALIGNMENT CHECK**

After connecting piping, rotate the pump drive shaft clockwise (view from motor end) by hand several complete revolutions to be sure there is no binding and that all parts are free. Recheck shaft alignment. If piping caused unit to be out of alignment, correct piping to relieve strain on the pump.

**IMPELLER CLEARANCES**

REF model pumps do not have impeller clearances that need to be adjusted. The design and assembly of the unit ensure that the impeller is placed in the proper position within the casing assembly.

FP-REI model pumps have impeller clearances that need to be adjusted during the motor installation process. All FP-REI models have a two-part, rubber spacer ring that is installed in the pump prior to shipment. This two-part spacer ring is held together with a zip tie. This ring's thickness spaces the shaft assembly in such a way that the impeller clearance is set properly with the spacer in place.

**FP-REI MOTOR ASSEMBLY**

See section step 6, page 27 for proper motor assembly procedure.

**MECHANICAL SEAL**

When the pump is intended to be equipped with a mechanical seal, it is American-Marsh's standard practice to install the mechanical seal in the pump prior to shipment. Specific order requirements may specify that the seal be shipped separately, or none be supplied. It is the pump installer's responsibility to determine if a seal was installed. If a seal was supplied but not installed, the seal and installation instructions will be shipped with the pump.

**! WARNING**

*Failure to ensure that a seal is installed may result in serious leakage of the pumped fluid.*

Seal and seal support system must be installed and operational as specified by the seal manufacturer.

The stuffing box/seal chamber/gland may have ports that have been temporarily plugged at the factory to keep out foreign matter. It is the installer's responsibility to determine if these plugs should be removed and external piping connected. Refer to the seal drawings and/or the

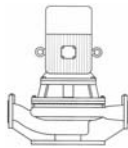
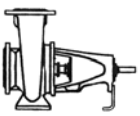

local American-Marsh representative for the proper connections.

### PACKING

When the pump is intended to be equipped with shaft packing, it is not American-Marsh's standard practice to install the packing in the stuffing box prior to shipment. The packing is shipped with the pump. It is the pump installer's responsibility to install the packing in the stuffing box.



*Failure to ensure that packing is installed may result in serious leakage of the pumped fluid.*

### PIPING CONNECTION – SEAL/PACKING SUPPORT SYSTEM



*If the pump has a seal support system, it is mandatory that this system be fully installed and operational before the pump is started.*

**Packing Lubrication** – All FP-REF pumps have a plan 1 flush (from the discharge) standard. Water, when compatible with the pumpage, can be introduced into Tap V (Figure 4) at pressure 10 to 15 lbf/in<sup>2</sup> (69 to 103 kPa) above the stuffing box pressure.

The gland should be adjusted to give a flow rate of 20 to 30 drops per minute for clean fluid. For abrasive applications, the regulated flow rate should be 1-2 gpm (0.06-0.13 l/s).

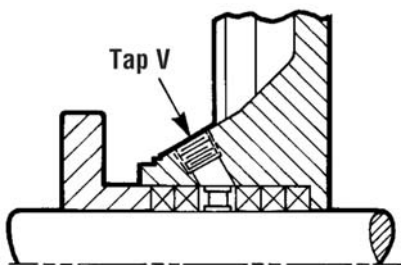

**FIGURE 4 – Packing Housing Arrangement**

Grease lubrication, when compatible with the pumpage, may be used. Again, introduced into Tap V. In non-abrasive applications the pumpage itself may be

sufficient to lubricate the packing without need for external lines. Tap V should be plugged.

**Abrasive Packing Arrangement** – The installation procedures are the same as the standard packing with some exceptions. A special lip seal is installed first, followed by two lantern ring assemblies, then two of the packing rings provided (Figure 5).

A flush line from a clean external source should be connected via Tap V, in the top of the stuffing box.

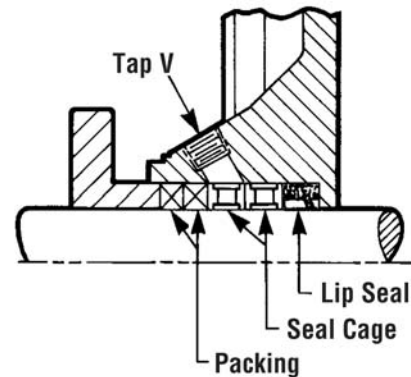

**FIGURE 5 – Abrasion Packing Arrangement**

### BEARING LUBRICATION

Reasonable care and proper lubrication of American-Marsh Pump bearings will result in many years of service.

#### OIL LUBRICATED BEARINGS

REF Oil lubricated pumps are shipped from the factory without oil in the bearing housings. Before the pump is started the oil reservoir must be filled with Royal Purple Synfilm 68, Shell Tellus 68, Texaco Rhonda 68, or equivalent high quality ISO 68 grade oil with anti-wear additives. The oil should be drained and replaced every 3 to 6 months depending on operating conditions.

FP-REF pumps can be supplied with grease packed bearings and are shipped from the factory pre-lubricated. Before the pump is started the bearings must be filled with Royal Purple NLGI #2 or other high quality equivalent grease.

FP-REI pumps depend on the driver bearings for support and therefore should be cared for as the manufacturer of the driver recommends.

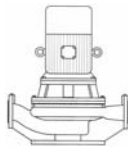
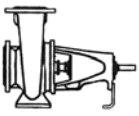

## DRIVER BEARINGS

Consult the driver manufacturer's maintenance instructions for lubricants and re-lubrication procedures for the driver.

## COUPLING

**A direction arrow is cast on the front of the casing and on the Bearing Housing. Make sure the motor rotates in the same direction before coupling the motor to the Pump.**

# ⚠ CAUTION

*It is absolutely essential that the rotation of the motor be checked before connecting the shaft coupling. Incorrect rotation of the pump, for even a short time, can dislodge the impeller which may cause serious damage to the pump. All RE pumps turn clockwise as viewed from the motor end or, conversely, counterclockwise when viewed from the suction end.*

The coupling should be installed as advised by the coupling manufacturer. Pumps are shipped without the spacer installed. If the spacer has been installed to facilitate alignment, then it must be removed prior to checking rotation. Remove protective material from the coupling and any exposed portions of the shaft before installing the coupling.

## PUMP OPERATION

### ROTATION CHECK

# ⚠ CAUTION

*It is absolutely essential that the rotation of the motor be checked before connecting the shaft coupling. Incorrect rotation of the pump, for even a short time, can dislodge and damage the impeller, casing, shaft and shaft seal.*

*All RE pumps turn clockwise as viewed from the motor end. A direction arrow is cast on the front of the casing. Make sure the motor rotates in the same direction.*

### PRE START-UP CHECKS

Prior to starting the pump it is essential that the following checks are made. These checks are all described in detail in the Maintenance Section of this booklet.

- Pump and Motor properly secured to the base plate
- All fasteners tightened to the correct torques
- Coupling guard in place and not rubbing
- Rotation check, see above
- **THIS IS ABSOLUTELY ESSENTIAL.**
- Shaft seal properly installed
- Seal support system operational
- Bearing lubrication
- Bearing housing cooling system operational
- Impeller clearances properly set
- Pump instrumentation is operational
- Pump is primed
- Rotation of shaft by hand

As a final step in preparation for operation, it is important to rotate the shaft by hand to be certain that all rotating parts move freely, and that there are no foreign objects in the pump.

### ENSURING PROPER NPSH<sub>A</sub>

Net Positive Suction Head – Available (NPSH<sub>A</sub>) is the measure of the energy in a liquid above the vapor pressure. It is used to determine the likelihood that a fluid will vaporize in the pump. It is critical because a centrifugal pump is designed to pump a liquid, not a vapor. Vaporization in a pump will result in damage to the pump, deterioration of the Total Differential Head (TDH), and possibly a complete stopping of pumping. Net Positive Suction Head – Required (NPSH<sub>R</sub>) is the decrease of fluid energy between the inlet of the pump, and the point of lowest pressure in the pump. This decrease occurs because of friction losses and fluid accelerations in the inlet region of the pump, and particularly accelerations as the fluid enters the impeller vanes. The value for NPSH<sub>R</sub> for the specific pump purchased is given in the pump data sheet, and on the pump performance curve.

For a pump to operate properly the NPSH<sub>A</sub> must be greater than the NPSH<sub>R</sub>. Good practice dictates that this margin should be at least 5 ft (1.5 m) or 20%, whichever is greater.

# ⚠ CAUTION

*Ensuring that NPSH<sub>A</sub> is larger than NPSH<sub>R</sub> by the suggested margin will greatly enhance pump performance and reliability. It will also reduce the likelihood of cavitation, which can severely damage the pump.*



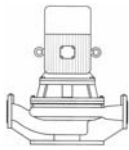
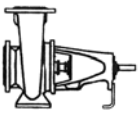

## MINIMUM FLOW

Minimum continuous stable flow is the lowest flow at which the pump can operate and still conform to the bearing life, shaft deflection and bearing housing vibration limits. Pumps may be operated at lower flows, but it must be recognized that the pump may not conform to one or more of these limits. For example, vibration may exceed the limit set by the ASME standard. The size of the pump, the energy absorbed, and the liquid pumped are some of the considerations in determining the minimum flow.

Typically, limitations of 10% of the capacity at the best efficiency point (BEP) should be specified as the minimum flow. However, American-Marsh has determined that several pumps must be limited to higher minimum flows to provide optimum service. The following are the recommended minimum flows for these specific pumps:

Pump Size	60 Hz		50 Hz	
	RPM	Minimum Flow (% of BEP)	RPM	Minimum Flow (% of BEP)
All 5" Impellers	3500	25%	2900	21%
All 7" Impellers	3500	25%	2900	21%
All 8" Impellers	3500	25%	2900	21%
All 10" Impellers	3500	33%	2900	28%
All 13" Impellers	1750	50%	1450	42%
All Other Sizes	ANY	20%	ANY	20%

**FIGURE 6 - Minimum Continuous Safe Flow**

**Note:** "Minimum intermittent flow" value of 50% of the "minimum continuous flow" as long as that flow is greater than the "minimum thermal flow."

All RE pumps also have a "Minimum Thermal Flow." This is defined as the minimum flow that will not cause an excessive temperature rise. Minimum Thermal Flow is application dependent.



*Do not operate the pump below Minimum Thermal Flow, as this could cause an excessive temperature rise. Contact an American-Marsh Sales Engineer for determination of Minimum Thermal flow.*

## STARTING THE PUMP AND ADJUSTING FLOW

1. Open the suction valve to full open position. It is very important to leave the suction valve open

ENGINEERED PROCESS GROUP

while the pump is operating. Any throttling or adjusting of flow must be done through the discharge valve. Partially closing the suction valve can create serious NPSH and pump performance problems.



*Never operate pump with both the suction and discharge valves closed. This could cause an explosion.*

2. A standard centrifugal pump will not move liquid unless the pump is primed. A pump is said to be "primed" when the casing and the suction piping are completely filled with liquid. Open discharge valve a slight amount. This will allow any entrapped air to escape and will normally allow the pump to prime, if the suction source is above the pump. When a condition exists where the suction pressure may drop below the pump's capability, it is advisable to add a low pressure control device to shut the pump down when the pressure drops below a predetermined minimum.
3. All cooling, heating, and flush lines must be started and regulated.
4. Start the driver (typically, the electric motor).
5. Slowly open the discharge valve until the desired flow is reached, keeping in mind the minimum flow restrictions listed above.



*It is important that the discharge valve be opened within a short interval after starting the driver. Failure to do this could cause a dangerous build up of heat, and possibly an explosion.*

6. **Reduced capacity**  
Avoid running a centrifugal pump at drastically reduced capacities or with discharge valve closed for extended periods of time. This can cause severe temperature rise and the liquid in the pump may reach its boiling point. If this occurs, the mechanical seal will be exposed to vapor, with no lubrication, and may score or seize to the stationary parts. Continued running under these conditions when the suction valve is also closed, can create an explosive condition due to the confined vapor at high pressure and temperature. Thermostats may be used to

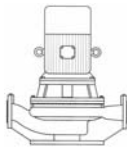
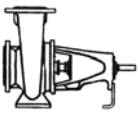

safeguard against over heating by shutting down the pump at a predetermined temperature.

Safeguards should also be taken against possible operation with a closed discharge valve, such as installing a bypass back to the suction source. The size of the bypass line and the required bypass flow rate is a function of the input horsepower and the allowable temperature rise.

7. *Reduced Head*

Note that when discharge head drops, the pump's flow rate usually increases rapidly. Check motor for temperature rise as this may cause overload. If overloading occurs, throttle the discharge.

8. *Surging Condition*

A rapidly closing discharge valve can cause a damaging pressure surge. A dampening arrangement should be provided in the piping.

## **OPERATION IN SUB-FREEZING CONDITIONS**

When using the pump in sub-freezing conditions where the pump is periodically idle, the pump should be properly drained or protected with thermal devices which will keep the liquid in the pump from freezing.

## **SHUTDOWN CONSIDERATIONS**

When the pump is being shutdown, the procedure should be the reverse of the start-up procedure. First, slowly close the discharge valve, shutdown the driver, then close the suction valve. Remember, closing the suction valve while the pump is running is a safety hazard and could seriously damage the pump and other equipment.

## **TROUBLESHOOTING**

The following is a guide to troubleshooting problems with American-Marsh pumps. Common problems are analyzed and solutions are offered. Obviously, it is impossible to cover every possible scenario. If a problem exists that is not covered by one of the examples, then contact a local American-Marsh Sales Engineer or Distributor/Representative for assistance.

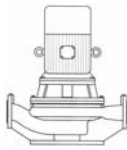
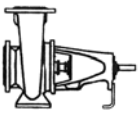

<b>PROBLEM</b>	<b>POSSIBLE CAUSE</b>	<b>RECOMMENDED REMEDY</b>
<b>Problem #1</b> Pump not reaching design flow rate.	1.1 Insufficient NPSH <sub>A</sub> . (Noise may not be present)	Recalculate NPSH available. It must be greater than the NPSH required by pump at desired flow. If not, redesign suction piping, holding number of elbows and number of planes to a minimum to avoid adverse flow rotation as it approaches the impeller.
	1.2 System head greater than anticipated.	Reduce system head by increasing pipe size and/ than or reducing number of fittings. Increase impeller diameter. NOTE: Increasing impeller diameter may require use of a larger motor.
	1.3 Entrained air. Air leak from atmosphere on suction side.	1. Check suction line gaskets and threads for tightness. 2. If vortex formation is observed in suction tank, install vortex breaker. 3. Check for minimum submergence.
	1.4 Entrained gas from process.	Process generated gases may require larger pumps.
	1.5 Speed too low.	Check motor speed against design speed.
	1.6 Direction of rotation wrong.	After confirming wrong rotation, reverse any two of three leads on a three phase motor. The pump should be disassembled and inspected before it is restarted.
	1.7 Impeller too small.	Replace with proper diameter impeller. NOTE: Increasing impeller diameter may require use of a larger motor.
	1.8 Plugged impeller, suction line or casing which may be due to a product or large solids.	1. Reduce length of fiber when possible. 2. Reduce solids in the process fluid when possible. 3. Consider larger pump.
	1.9 Wet end parts (casing cover, impeller) worn, corroded or missing.	Replace part or parts.
<b>Problem #2.0</b> Pump not reaching design head (TDH).	2.1 Refer to possible causes under Problem #1.0.	Refer to remedies listed under Problem #1.0 and #3.0.
<b>Problem #3.0</b> No discharge or flow	3.1 Not properly primed.	Repeat priming operation, recheck instructions. If pump has run dry, disassemble and inspect the pump before operation.
	3.2 Direction of rotation wrong.	After confirming wrong rotation, reverse any two of three leads on a three phase motor. The pump should be disassembled and inspected before operation.

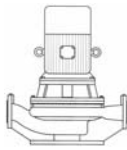
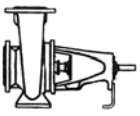

<b>PROBLEM</b>	<b>POSSIBLE CAUSE</b>	<b>RECOMMENDED REMEDY</b>
<b>Cont. Problem #3.0</b> No discharge or flow	3.3 Entrained air. Air leak from atmosphere on suction side.	Refer to recommended remedy under Problem #1.0, Item #1.3.
	3.4 Plugged impeller, suction line or casing which may be due to a fibrous product or large solids.	Refer to recommended remedy under Problem #1.0, Item #1.8.
	3.5 Damaged pump shaft, impeller.	Replace damaged parts.
<b>Problem #4.0</b> Pump operates for short period, then loses prime.	4.1 Insufficient NPSH.	Refer to recommended remedy under Problem #1.0, Item #1.1.
	4.2 Entrained air. Air leak from atmosphere on suction side.	Refer to recommended remedy under Problem #1.0, Item #1.3.
<b>Problem #5.0</b> Excessive noise from wet end.	5.1 Cavitation - insufficient NPSH available.	Refer to recommended remedy under Problem #1.0, Item #1.1.
	5.2 Abnormal fluid rotation due to complex suction piping.	Redesign suction piping, holder number of elbows and number of planes to a minimum to avoid adverse fluid rotation as it approaches the impeller.
	5.3 Impeller rubbing.	1. Check outboard bearing assembly for axial end play (REF Models). 2. Reset impeller clearance (REC & REI Models).
<b>Problem #6.0</b> Excessive noise from power end.	6.1 Bearing contamination appearing on the raceways as scoring, pitting, scratching, or rusting caused by adverse environment and entrance of abrasive contaminants from atmosphere.	1. Work with clean tools in clean surroundings. 2. Remove all outside dirt from housing before exposing bearings. 3. Handle with clean dry hands. 4. Treat a used bearing as carefully as a new one. 5. Use clean solvent and flushing oil. 6. Protect disassembled bearing from dirt and moisture. 7. Keep bearings wrapped in paper or clean cloth while not in use. 8. Clean inside of housing before replacing bearings. 9. Check oil seals and replace as required. 10. Check all plugs and tapped openings to make sure that they are tight.
	6.2 Brinelling of bearing identified by indentation on the ball races, usually caused by incorrectly applied forces in assembling the bearing or by shock loading such as hitting the bearing or drive shaft with a hammer.	When mounting the bearing on the drive shaft use a proper size ring and apply the pressure against the inner ring only. Be sure when mounting a bearing to apply the mounting pressure slowly and evenly.



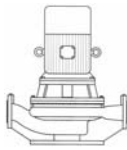
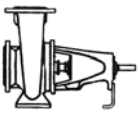

PROBLEM	POSSIBLE CAUSE	RECOMMENDED REMEDY
<p><b>Cont. Problem #6.0</b> Excessive noise from power end.</p>	<p>6.3 False brinelling of bearing identified again by either axial or circumferential indentations usually caused by vibration of the balls between the races in a stationary bearing.</p>	<p>1. Correct the source of vibration. 2. Where bearings are oil lubricated and employed in units that may be out of service for extended periods, the drive shaft should be turned over periodically to re-lubricate all bearing surfaces at intervals of one-to three months.</p>
	<p>6.4 Thrust overload on bearing identified by flaking ball path on one side of the outer race or in the case of maximum capacity bearings, may appear as a spalling of the races in the vicinity of the loading slot. (Please note: maximum capacity bearings are not recommended in REF pumps.) These thrust failures are caused by improper mounting of the bearing or excessive thrust loads.</p>	<p>1. Follow correct mounting procedures for bearings.</p>
	<p>6.5 Misalignment identified by fracture of ball retainer or a wide ball path on the inner race and a narrower cocked ball path on the outer race. Misalignment is caused by poor mounting practices or defective drive shaft. For example bearing not square with the centerline or possibly a bent shaft due to improper handling.</p>	<p>Handle parts carefully and follow recommended mounting procedures. Check all parts for proper fit and alignment.</p>
	<p>6.6 Bearing damaged by electric arcing identified as electro-etching of both inner and outer ring as a pitting or cratering. Electrical arcing is caused by a static electrical charge emanating from belt drives, electrical leakage or short circuiting.</p>	<p>1. Where current shunting through the bearing cannot be corrected, a shunt in the form of a slip ring assembly should be incorporated. 2. Check all wiring, insulation and rotor windings to be sure that they are sound and all connections are properly made. 3. Where pumps are belt driven, consider the elimination of static charges by proper grounding or consider belt material that is less generative.</p>

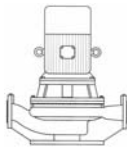
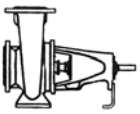

<b>PROBLEM</b>	<b>POSSIBLE CAUSE</b>	<b>RECOMMENDED REMEDY</b>
Cont.: <b>Problem #6.0</b> Excessive noise from power end.	6.7 Bearing damage due to improper lubrication, identified by one or more of the following: 1. Abnormal bearing temperature rise. 2. A stiff cracked grease appearance. 3. A brown or bluish discoloration of the bearing races.	1. Be sure the lubricant is clean. 2. Be sure proper amount of lubricant is used. The constant level oiler supplied with FP-REF pumps will maintain the proper oil level if it is installed and operating properly. In the case of greased lubricated bearings, be sure that there is space adjacent to the bearing into which it can rid itself of excessive lubricant, otherwise the bearing may overheat and fail prematurely. 3. Be sure the proper grade of lubricant is used.

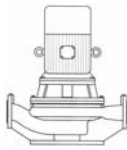
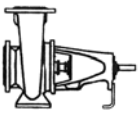

## MAINTENANCE

### PREVENTIVE MAINTENANCE

The following sections of this manual give instructions on how to perform a complete maintenance overhaul. However, it is also important to periodically repeat the "Pre start-up checks" listed on page 13. These checks will help extend pump life as well as the length of time between major overhauls.

### NEED FOR MAINTENANCE RECORDS

A procedure for keeping accurate maintenance records is a critical part of any program to improve pump reliability. There are many variables that can contribute to pump failures. Often long term and repetitive problems can only be solved by analyzing these variables through pump maintenance records.

### NEED FOR CLEANLINESS

One of the major causes of pump failure is the presence of contaminants in the bearing housing. This contamination can be in the form of moisture, dust, dirt and other solid particles such as metal chips. Contamination can also be harmful to the mechanical seal (especially the seal faces) as well as other parts of the pumps. For example, dirt in the impeller threads could cause the impeller to not be seated properly against the shaft. This, in turn, could cause a series of other problems. For these reasons, it is very important that proper cleanliness be maintained. Some guidelines are listed below.

After draining the oil from the bearing housing, periodically send it out for analysis. If it is contaminated, determine the cause and correct. The work area should be clean and free from dust, dirt, oil, grease, etc. Hands and gloves should be clean. Only clean towels, rags, and tools should be used.

### DISASSEMBLY

Refer to the parts list shown in Figures 16, 17 & 18 for item number references used throughout this section.

### REF MODELS

1. Before performing any maintenance, disconnect the driver from its power supply and lock it off line.

**! DANGER**

*Lock out power to driver to prevent personal injury.*

2. Close the discharge and suction valves, and drain all liquid from the pump.
3. Close all valves on auxiliary equipment and piping, then disconnect all auxiliary piping.
4. Decontaminate the pump as necessary. If American-Marsh pumps contain dangerous chemicals, it is important to follow plant safety guidelines to avoid personal injury or death.
5. Remove the coupling guard.
6. Remove the spacer from the coupling (if supplied).
7. Remove casing fasteners (#383F).
8. Remove the fasteners holding the bearing housing foot to the base plate.
9. Move the power frame (#2B) and rear cover (#2D) assembly away from the casing (#1A). Discard the casing/cover gasket (#351A).

**! DANGER**

*The power frame and rear cover assembly is heavy. It is important to follow plant safety guidelines when lifting it.*

10. Inspect the casing (#1A) and the case wear ring (#15A) for damage. If the casing (#1A) shows any signs of damage, replace it. If the case wear ring (#15A) is damaged, pry it from the casing (#1A). Press new case wear ring (#15A) into casing (#1A) by using equal force around the case wear ring (#15A) until it is seated securely in casing (#1A).
11. Transport the back pull-out assembly to the maintenance shop.
12. Remove the coupling hub from the pump shaft (#41A).
13. Bend the impeller washer (#27A) flat so that the impeller nut (#24B) can be loosened. Loosen and remove the impeller nut (#24B) and the impeller washer (#27A). Discard the impeller washer (#27A). The impeller (#11A) should be free to remove from the shaft (#41A). Remove the impeller key (#24A) from the shaft (#41A).

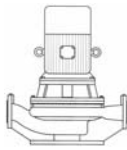
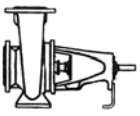

# CAUTION

*Do not apply heat to the impeller. If liquid is entrapped in the hub, an explosion could occur.*

## INTERNAL COMPONENT MECHANICALLY SEALED PUMPS

If pump is of the packed orientation, skip to step 19.

14. Remove the mechanical seal (#331B) from the shaft (#41A).
15. Remove the shaft sleeve (#42A) from the shaft (#41A). Discard the shaft sleeve o-ring (#331C).
16. Remove rear cover nuts (#385F) and carefully remove the rear cover (#2D) from the power frame.
17. Carefully press the stationary part of the mechanical seal out of the rear cover (#2D). Discard and replace the mechanical seal (#331B) if damaged.
18. Inspect the rear cover (#2D) for damage or excessive wear and replace if necessary. Be sure to inspect and clean the internal flush port. It is critical that this flush port is clear of all debris due to the fact that it lubricates the mechanical seal (#331B).

## EXTERNAL MECHANICALLY SEALED OR PACKED PUMPS

19. Loosen and remove the gland nuts (#72D).
20. If a cartridge type mechanical seal is used, loosen the set screws which lock the unit to the shaft and remove the complete seal assembly. If the seal is to be reused, the spacing clips or tabs should be reinstalled prior to loosening the set screws. This will ensure that the proper seal compression is maintained.
21. If a component type outside mechanical seal is used, remove the gland and the stationary seat from the rear cover (#2D). Once the rear cover (#2D) has been removed, remove the stationary seat from the gland. Loosen the set screws in the rotating unit and remove it. Discard all O-rings and gaskets.
22. Remove rear cover nuts (#385F) and carefully remove the rear cover (#2D) from the power frame.
23. If packing (#331A) is used, remove it and the lantern ring (#73A). Remove the gland (#71A).
24. Remove the shaft sleeve (#42A) from the shaft (#41A). Discard the shaft sleeve o-ring (#331C).

25. If the power frame is oil lubricated, remove the drain plug and drain the oil from the bearing housing (#2B).
26. Remove the shaft deflector (#46A).
27. Remove the inboard bearing cap cap screws (#384B). Remove the inboard bearing cap (#85P). Remove and discard the inboard bearing cap gasket (#359A). Remove and discard the inboard bearing cap oil lip seal ((#104P). If bearing isolators are used, refer to Appendix B. If magnetic seals are used, maintain the seals as specified by the manufacturer.
28. Remove the outboard bearing cap cap screws (#384B). Remove the outboard bearing cap (#85N). Remove and discard the outboard bearing cap gasket (#359A). Remove and discard the outboard bearing cap oil lip seal (#104P). If bearing isolators are used, refer to Appendix B. If magnetic seals are used, maintain the seals as specified by the manufacturer.
29. Press the shaft assembly (consisting of the shaft (#41A), the inboard bearing (#81P) and the outboard bearing (#81N)) out of the bearing housing (#2B).
30. An arbor or hydraulic press may be used to remove the bearings (#81N and #81P) from the shaft. It is extremely important to apply even pressure to the inner bearing race only. Never apply pressure to the outer race as this exerts excess load on the balls and causes damage.

# CAUTION

*Applying pressure to the outer race could permanently damage the bearings.*

31. If present, the Trico oiler should be removed from the bearing housing.
32. The sight gage should be removed from the bearing housing.

## REC & REI MODELS

1. Before performing any maintenance, disconnect the driver from its power supply and lock it off line.

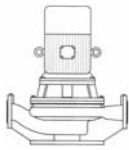
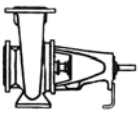

**AMERICAN-MARSH PUMPS**

## **! DANGER**

*Lock out power to driver to prevent personal injury.*

2. Close the discharge and suction valves, and drain all liquid from the pump.
3. Close all valves on auxiliary equipment and piping, then disconnect all auxiliary piping.
4. Decontaminate the pump as necessary. If American-Marsh pumps contain dangerous chemicals, it is important to follow plant safety guidelines to avoid personal injury or death.
5. Remove casing fasteners (#383F).
6. Move the rear cover (#2D) and shaft & bracket assembly away from the casing (#1A). Discard the casing/cover gasket (#351A).

## **! DANGER**

*The rear cover assembly and shaft & bracket assembly is heavy. It is important to follow plant safety guidelines when lifting it.*

7. Inspect the casing (#1A) and the case wear ring (#15A) for damage. If the casing (#1A) shows any signs of damage, replace it. If the case wear ring (#15A) is damaged, pry it from the casing (#1A). Press new case wear ring (#15A) into casing (#1A) by using equal force around the case wear ring (#15A) until it is seated securely in casing (#1A).
8. Transport the back pull-out assembly to the maintenance shop.
9. Bend the impeller washer (#27A) flat so that the impeller nut (#24B) can be loosened. Loosen and remove the impeller nut (#24B) and the impeller washer (#27A). Discard the impeller washer (#27A). The impeller (#11A) should be free to remove from the shaft (#41A). Remove the impeller key (#24A) from the shaft (#41A).

## **! CAUTION**

*Do not apply heat to the impeller. If liquid is entrapped in the hub, an explosion could occur.*

10. Remove the mechanical seal (#331B) from the shaft (#41A).
11. Remove the shaft sleeve (#42A) from the shaft (#41A). Discard the shaft sleeve o-ring (#331C).
12. Remove rear cover nuts (#385F) and carefully remove the rear cover (#2D) from the bracket assembly (#2E).
13. Carefully press the stationary part of the mechanical seal out of the rear cover (#2D). Discard and replace the mechanical seal (#331B) if damaged.
14. Inspect the rear cover (#2D) for damage or excessive wear and replace if necessary. Be sure to inspect and clean the internal flush port. It is critical that this flush port is clear of all debris due to the fact that it lubricates the mechanical seal (#331B).
15. If the motor is to be removed from the bracket (#2E) and shaft (#41A), loosen and remove the shaft set screws (#47A). Carefully pull the motor off of the bracket (#2E) and shaft (#41A).

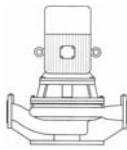
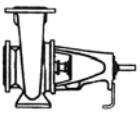

### CLEANING/INSPECTION

All parts should now be thoroughly cleaned and inspected. New bearings, O-rings, gaskets, and lip seals should be used. Any parts that show wear or corrosion should be replaced with new genuine American-Marsh parts.



*It is important that only non-flammable, non-contaminated cleaning fluids are used. These fluids must comply with plant safety and environmental guidelines.*

### ASSEMBLY

**Note:** Refer to Figure 7 for all bolt torque information.

It is very important that all pipe threads be sealed properly. PTFE tape provides a very reliable seal over a wide range of fluids, but it has a serious shortcoming if not used properly. If, during application to the threads, the tape is wrapped over the end of the male thread, strings of the tape will be formed off when threaded into the female fitting. This string can then tear away and lodge in the piping system. If this occurs in the seal flush system, small orifices can become blocked effectively shutting off flow. For this reason, American-Marsh does not recommend the use of PTFE tape as a thread sealant.

American-Marsh has investigated and tested alternate sealants and has identified two that provide an effective seal, have the same chemical resistance as the tape, and will not plug flush systems. These are La-co SlicTite and Bakerseal. Both products contain finely ground PTFE particles in an oil based carrier. They are supplied in a paste form which is brushed on the male pipe threads. American-Marsh recommends using one of these paste sealants.

Full thread length engagement is required for all fasteners.

BOLT SIZE		TIGHTENING TORQUE	
Metric	Standard	Lbf ft	Nm
4 mm	5/32"	2.7	3.6
5 mm	3/16"	5.2	7.0
6 mm	1/4"	8.9	12.0
7 mm	9/32"	14.6	19.8
8 mm	5/16"	21.8	29.6
9 mm	11/32"	28.0	38.0
10 mm	3/8"	38.7	52.5
12 mm	1/2"	65.6	89.0
14 mm	9/16"	99.6	135
16 mm	5/8"	151	205
18 mm	11/16"	190	257
20 mm	3/4"	264	358
22 mm	7/8"	321	435
24 mm	15/16"	411	557

**FIGURE 7 - Bolt & Cap Screw Torque Ratings**

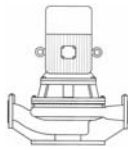
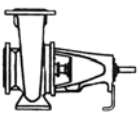

## REF POWER FRAME ASSEMBLY

### BEARING INSTALLATION

Mounting of bearings on shafts must be done in a clean environment. Bearing and power end life can be drastically reduced if even very small foreign particles work their way into the bearings.

Bearings should be removed from their protective packaging only immediately before assembly to limit exposure to possible contamination. After removing the packaging they should only come in contact with clean hands, fixtures, tools and work surfaces.

The chart shown in Figure 8 gives the SKF part numbers for bearings in American-Marsh FP-REF pumps. Note that the term “inboard bearing” refers to the bearing nearest to the casing. “Outboard bearing” refers to the bearing nearest to the motor.

1. Install the inboard bearing (#81P) on the shaft (#41A). The inboard bearing must be positioned against the shoulder. If the power end is equipped with single shield re-greaseable bearings, the shields should be placed next to the shaft shoulder.

Power Frame	Type of Bearings	Inboard Single Row, Deep Groove <sup>⑤</sup>	Outboard Single Deep Groove <sup>⑤</sup>	Optional Outboard Duplex Angular Contact <sup>⑤</sup>
25A 25B	Oil bath/mist – Open <sup>①</sup> Regreasable – Single Shielded <sup>②</sup> Greased for life – Double Shielded <sup>③</sup> Sealed for life – Double Sealed <sup>④</sup>	6305-C3 6305-ZC3 6305-2ZC3 6305-2RSIC3	6305-C3 6305-ZC3 6305-2ZC3 6305-2RSIC3	7305-BECBY NA <sup>⑥</sup> NA <sup>⑦</sup> NA <sup>⑦</sup>
35	Oil bath/mist – Open <sup>①</sup> Regreasable – Single Shielded <sup>②</sup> Greased for life – Double Shielded <sup>③</sup> Sealed for life – Double Sealed <sup>④</sup>	6307-C3 6307-ZC3 6307-2ZC3 6307-2RSIC3	6307-C3 6307-ZC3 6307-2ZC3 6307-2RSIC3	7307-BECBY NA <sup>⑥</sup> NA <sup>⑦</sup> NA <sup>⑦</sup>
45	Oil bath/mist – Open <sup>①</sup> Regreasable – Single Shielded <sup>②</sup> Greased for life – Double Shielded <sup>③</sup> Sealed for life – Double Sealed <sup>④</sup>	6309-C3 6309-ZC3 6309-2ZC3 6309-2RSIC3	6309-C3 6309-ZC3 6309-2ZC3 6309-2RSIC3	7309-BECBY NA <sup>⑥</sup> NA <sup>⑦</sup> NA <sup>⑦</sup>
55	Oil bath/mist – Open <sup>①</sup> Regreasable – Single Shielded <sup>②</sup> Greased for life – Double Shielded <sup>③</sup> Sealed for life – Double Sealed <sup>④</sup>	6311-C3 6311-ZC3 6311-2ZC3 6311-2RSIC3	6311-C3 6311-ZC3 6311-2ZC3 6311-2RSIC3	7311-BECBY NA <sup>⑥</sup> NA <sup>⑦</sup> NA <sup>⑦</sup>
60	Oil bath/mist – Open <sup>①</sup> Regreasable – Single Shielded <sup>②</sup> Greased for life – Double Shielded <sup>③</sup> Sealed for life – Double Sealed <sup>④</sup>	6312-C3 6312-ZC3 6312-2ZC3 6312-2RSIC3	6312-C3 6312-ZC3 6312-2ZC3 6312-2RSIC3	7312-BECBY NA <sup>⑥</sup> NA <sup>⑦</sup> NA <sup>⑦</sup>
70	Oil bath/mist – Open <sup>①</sup> Regreasable – Single Shielded <sup>②</sup> Greased for life – Double Shielded <sup>③</sup> Sealed for life – Double Sealed <sup>④</sup>	6314-C3 6314-ZC3 6314-2ZC3 6314-2RSIC3	6314-C3 6314-ZC3 6314-2ZC3 6314-2RSIC3	7314-BECBY NA <sup>⑥</sup> NA <sup>⑦</sup> NA <sup>⑦</sup>

**FIGURE 8 – AMP REF Bearings**

① These bearings are open on both sides. They are lubricated by oil bath or oil mist.

② These bearings are pre-greased by American-Marsh. Replacement bearings will generally not be pre-greased, so grease must be applied by the user. They have a single shield, which is located on the side next to the grease buffer, or reservoir. The bearings draw grease from the reservoir as it is needed. The shield protects the bearing from getting too much grease, which would generate heat. The grease reservoir is initially filled with grease by American-Marsh. Lubrication fittings are provided, to allow the customer to periodically replenish the grease, as recommended by the bearing and/or grease manufacturer.

③ These bearings are shielded on both sides. They come pre-greased by the bearing manufacturer. The user does not need to re-grease these bearings. The shields do not actually contact the bearing race, so no heat is generated.

④ These bearings are sealed on both sides. They come pre-greased by the bearing manufacturer. The user does not need to re-grease these bearings. The seals physically contact and rub against the bearing race, which generates heat. These bearings are not recommended at speeds above 1750 RPM.

⑤ The codes shown are SKF codes. Inboard and outboard bearings have the C3, greater than “Normal” clearance. These clearances are recommended by SKF to maximize bearing life.

⑥ Re-greaseable – Single Shielded bearings are not available in the duplex configuration; however, open oil bath-type bearings can be used for the re-greaseable configuration. These bearings must be pre-greased during assembly. Lubrication fittings are provided, to allow the user to periodically replenish the grease, as recommended by the bearing and/or grease manufacturer.

⑦ Not available.



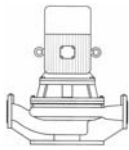
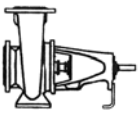

**BEARING INSTALLATION  
FOR POWER END ASSEMBLY (CONT'D)**

Both bearings have a slight interference fit which requires that they be pressed on the shaft with an arbor or hydraulic press. Even force should be applied to the inner race only. Never press on the outer race, as the force will damage the balls and races. An alternate method of installing bearings is to heat the bearings to 200°F (93°C) in an oven or induction heater. Then place them quickly in position on the shaft.

Pump	Press Force lbf (N)
25A/25B	1300 (5,780)
35	
45	2500 (11,100)
55	
60	4500 (20,000)
70	

**FIGURE 9 – Bearing Press Force**

**! CAUTION**

*Never heat the bearings above 230°F (110°C). To do so will likely cause the bearing fits to permanently change, leading to early failure.*

- Using clean gloves, install the outboard bearing (#121) firmly against the shoulder as shown in Figure 9. If hot bearing mounting techniques are used, steps must be taken to ensure the outboard bearing is firmly positioned against the shaft shoulder. The outboard bearing, while still hot, is to be positioned against the shaft shoulder. After the bearing has cooled below 100°F (38°C) the bearing should be pressed against the shaft shoulder. An approximate press force needed to seat the bearing is listed in Figure 9. This value may be used if the press has load measuring capability.

**! CAUTION**

*It must be understood that fixtures and equipment used to press the bearing must be designed so no load is ever transmitted through the bearing balls. This would damage the bearing.*

**! CAUTION**

*Never heat the bearings above 230°F (110°C). To do so will likely cause the bearing fits to permanently change, leading to early failure.*

- If the outboard bearing is cold pressed against the shaft shoulder, it should be pressed onto the shaft with the forces listed in Figure 9.
- Duplex angular contact bearings must be mounted back to back with the wider thrust sides of the outer races in contact with each. Only bearings designed for universal mounting should be used. SKF's designation is "BECB". NTN's designation is "G".  
Note: A special shaft is required when using duplex angular contact bearings.

**LIP SEALS**

- If lip seals (#104N & #104P) were used, install new lip seals in the bearing housing caps (#85N & 85P).
- Bolt the inboard and outboard bearing housing caps (#85N & 85P) to the bearing housing (#2B) remembering to install new inboard and outboard bearing housing cap gaskets (#359A).

**LABYRINTH SEALS**

Refer to Appendix A.

**MAGNETIC SEALS**

Follow the installation instructions provided by the manufacturer.

- Install a sight gage and or oil eye into the bearing housing.
- If one was present, install a Trico oiler into the bearing housing. If not used, install a plug into the hole. When using a Trico oiler it is very important that a vent/breather be installed in the tapped hole on top of the bearing housing.
- Install a drain plug into the bearing housing. Be sure to install the optional magnetic drain plug, if appropriate.
- Install the shaft deflector (#46A).
- Install a new shaft sleeve o-ring (#331C). Place the shaft sleeve (#42A) onto the shaft (#41A).



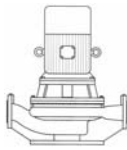
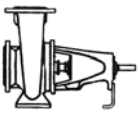

## REF WET END ASSEMBLY

Refer to the appropriate section according to construction details.

### INTERNAL COMPONENT MECHANICAL SEALS (STANDARD)

12. Press the stationary part of the mechanical seal into the rear cover (#2D) taking care not to damage the mechanical seal.
13. Install the rear cover plate (#2D) to the bearing housing (#2B) using studs (#385E) and nuts (#385F).
14. Install the rotating part of the mechanical seal onto the shaft sleeve using a seal guide following the seal manufacturer's instructions.
15. Install the impeller key (#24A). Install the impeller (#11A) onto the shaft (#41A). Install a new impeller washer (#27A) and impeller nut (#24B). Tighten the impeller nut (#24B) and bend the impeller washer (#27A) to lock into place.

### CARTRIDGE MECHANICAL SEALS

16. Slide the cartridge seal onto the shaft using a seal guide until it lightly touches the bearing housing.
17. Install the rear cover (#2D). Tighten the rear cover (#2D) to the bearing housing (#2B). Install the cartridge seal gland to the rear cover plate (#2D) using studs (#72G) and nuts (#72D). Tighten set screws on the seal to lock the rotating unit to the shaft. Finally, remove centering clips from the seal.

### EXTERNAL COMPONENT TYPE MECHANICAL SEAL

18. Install the rear cover (#2D) to the bearing housing (#2B).
19. Put blueing on the shaft in the area near the face of the seal chamber (rear cover #2D). Scribe a mark on the shaft at the face of the seal chamber. Now the location of the seal can be determined by referring to the seal drawing supplied by the seal manufacturer.
20. Remove the rear cover (#2D).
21. Install the mechanical seal gland and stationary seal components following the seal manufacturer's instructions. Slide the gland and stationary seal components onto the shaft until it lightly touches the bearing housing or adapter. Install the gland gasket into the gland.
22. Install the rotating part of the mechanical seal onto the shaft sleeve using a seal guide following the seal manufacturer's instructions.
23. Install the rear cover (#2D) to the bearing housing (#2B). Now, install the mechanical seal

gland to the rear cover (#2D) using studs (#72G) and nuts (#72D).

24. Install the impeller key (#24A). Install the impeller (#11A) onto the shaft (#41A). Install a new impeller washer (#27A) and impeller nut (#24B). Tighten the impeller nut (#24B) and bend the impeller washer (#27A) to lock into place.

### PACKING WITH SPLIT GLAND

25. Install the rear cover plate (#2D) to the bearing housing (#2B) using studs (#385E) and nuts (#385F).
26. Install the impeller key (#24A). Install the impeller (#11A) onto the shaft (#41A). Install a new impeller washer (#27A) and impeller nut (#24B). Tighten the impeller nut (#24B) and bend the impeller washer (#27A) to lock into place.
27. Install the packing rings (#331A) and lantern ring (#73A) into the stuffing box as shown in Figure 16. Always stagger the end gaps 90° to ensure a better seal. To speed installation of each ring, have an assistant turn the pump shaft in one direction. This movement of the shaft will tend to draw the rings into the stuffing box. A split gland (#71A) is an assembly of two matched gland halves that are bolted together. Unbolt the gland halves and install the gland halves around the shaft. Bolt the halves together to form a gland assembly. Now, install the gland assembly (#71A) using studs (#72G) and nuts (#72D). Lightly snug up the gland. Final adjustments must be made after the pump has begun operation.

### PACKING WITH ONE PIECE GLAND

28. Slip gland over shaft and slide back to the bearing housing.
29. Install the rear cover plate (#2D) to the bearing housing (#2B) using studs (#385E) and nuts (#385F).
30. Install the impeller key (#24A). Install the impeller (#11A) onto the shaft (#41A). Install a new impeller washer (#27A) and impeller nut (#24B). Tighten the impeller nut (#24B) and bend the impeller washer (#27A) to lock into place.
31. Install the packing rings (#331A) and lantern ring (#73A) into the stuffing box as shown in Figure 16. Always stagger the end gaps 90° to ensure a better seal. To speed installation of each ring, have an assistant turn the pump shaft in one direction. This movement of the shaft will tend to draw the rings into the stuffing box. Now, attach the gland (#71A) to the rear cover using studs (#72G) and nuts (#72D). Lightly snug up

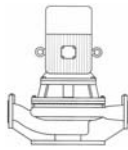
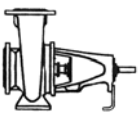

the gland. Final adjustments must be made after the pump has begun operation.

## BEARING LUBRICATION

### OIL BATH

The standard bearing housing bearings are oil bath lubricated and are not lubricated by American-Marsh. Before operating the pump, fill the bearing housing to the center of the oil sight glass with the proper type oil. (See Figure 10 for approximate amount of oil required – do not overfill.) The oil level in the bearing housing must be maintained at  $\pm 1/8$  in ( $\pm 3$  mm) from the center of the sight glass. The sight glass has a  $1/4$  in (6 mm) hole in the center of its reflector. The bearing housing oil level must be within the circumference of the center hole to ensure adequate lubrication of the bearings.

Pump	REF Oil Capacity
25A/25B	20 oz (590 ml)
35	30 oz (890 ml)
45	60 oz (1775 ml)
55	50 oz (1480 ml)
60	50 oz (1480 ml)
70	60 oz (1775 ml)

**FIGURE 10 – Approximate Amount Of Oil Required**

Mineral Oil	Quality mineral oil with rust and oxidation inhibitors. Mobil DTE Heavy/Medium ISO VG 68 or equivalent.
Synthetic	Royal Purple SynFilm 68, Conoco SYNCON 68 or equivalent. Some synthetic lubricants require Viton O-rings.
Grease	Royal Purple NLGI #2, Chevron SRI #2 (or compatible)

**FIGURE 11 – Recommended Lubricants**

Maximum Oil Temperature	ISO Viscosity Grade	Minimum Viscosity Index
Up to 160°F (71°C)	46	95
160-175°F (71°-80°C)	68	95
175-200°F (80°-94°C)	100	95

**FIGURE 12 – Oil Viscosity Grades**

See Figure 11 for recommended lubricants. **DO NOT USE DETERGENT OILS.** The oil must be free of water, sediment, resin, soaps, acid and fillers of any kind. It should contain rust and oxidation inhibitors. The proper oil viscosity is determined by the bearing housing operating temperature as given in Figure 12. To add oil to the housing, clean and then remove the vent plug at

the top of the bearing housing, pour in oil until it is visually half way up in the sight glass. Fill the constant level oiler bottle (Trico), if used, and return it to its position. The correct oil level is obtained with the constant level oiler in its lowest position, which results in the oil level being at the top of the oil inlet pipe nipple, or half way up in the sight glass window. Oil must be visible in the bottle at all times. As stated above, proper oil level is the center of the “bull’s eye” sight glass.

Lubrication	Temperature
Oil bath	180°F* (82°C)
Grease	200°F* (94°C)

\* Assuming good maintenance and operation practices, and no contamination.

**FIGURE 13 – Maximum External Housing Temperature**

In many pumping applications lubricating oil becomes contaminated before it loses its lubricating qualities or breaks down. For this reason it is recommended that the first oil change take place after approximately 160 hours of operation, at which time, the used oil should be examined carefully for contaminants. During the initial operating period monitor the bearing housing operating temperature. Record the external bearing housing temperature. See Figure 13 for maximum acceptable temperatures. The normal oil change interval is based on temperature and is shown in Figure 14.

### GREASE

#### *Single shielded re-greasable bearings*

When the grease lubrication option is specified, single shielded bearings, grease fittings and vent pipe plugs are installed inboard and outboard. The bearings are packed with Royal Purple NLGI #2 grease prior to assembly. For initial lubrication, apply grease through the fittings until it comes out of the vent holes, then reinstall the pipe plugs. For re-lubrication, a grease with the same type base (non-soap polyuride) and oil (mineral) should be used. To re-grease, remove the pipe plug from both the inboard and outboard bearing location.



*To re-grease bearings under coupling guard, stop pump, lock the motor, remove coupling guard, then re-grease the bearings.*

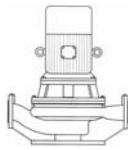
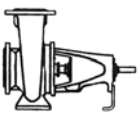

Lubricant	Under 160°F (71°C)	160-175°F (71-80°C)	175-200°F (80-94°C)
Grease	6 mo	3 mo	1.5 mo
Mineral Oil	6 mo	3 mo	1.5 mo
Synthetic Oil**	18 mo	18 mo	18 mo

**FIGURE 14 – Re-lubrication Intervals**

## **CAUTION**

*Do not fill the housing with oil when greased bearings are used. The oil will leach the grease out of the bearings and the life of the bearings may be drastically reduced.*

*Double shielded or double sealed bearings*  
These bearings are packed with grease by the bearing manufacturer and should not be re-lubricated. Maintenance intervals for these bearings are greatly affected by their operating temperature and pump speed. However, the shielded bearing typically operates cooler, thus extending its life.

### **FP-REI FLUID ASSEMBLY**

1. Press the stationary part of the mechanical seal into the rear cover (#2D) taking care not to damage the mechanical seal.
2. Install the rear cover plate (#2D) to the bracket assembly (#2E) using studs (#385E) and nuts (#385F).
3. Install a new shaft sleeve o-ring (#331C). Install the shaft (#41A) into the rear cover (#2D) using the rubber, two-part seal spacer. This rubber two-part spacer ensures that the shaft is in the proper axial position.
4. Place the shaft sleeve (#42A) onto the shaft (#41A). Install the rotating part of the mechanical seal onto the shaft sleeve using a seal guide following the seal manufacturer's instructions.
5. Install the impeller key (#24A). Install the impeller (#11A) onto the shaft (#41A). Install a new impeller washer (#27A) and impeller nut (#24B). Tighten the impeller nut (#24B) and bend the impeller washer (#27A) to lock into place.

### **REC & REI SHAFT AND BRACKET ASSEMBLY**

6. Mount the motor to the bracket assembly (#2E) engaging the motor shaft into the pump shaft

(#41A). It is extremely important that the keyways are engaged properly.

7. Dimple the motor shaft at one of the set screw locations (#47A). Install all shaft set screws (#47A) by applying a small amount of blue Loctite on the threads. Torque the set screws (#47A) to the appropriate values listed in Figure 15.

Size in.	Seating Torque in.-lbs.	Holding Power lb.
0.2500	87	1000
0.3125	165	1500
0.3750	290	2000
0.4375	430	2500
0.5000	620	3000
0.5625	620	3500
0.6250	1325	4000
0.7500	2400	5000
0.8750	5200	6000
1.0000	7200	7000

Based on alloy steel set screw against steel shaft, class 3A course or fine threads in class 2B holes and cup point socket set screws.

**FIGURE 15 – Set Screw Torque Values**

### **PUMP REINSTALLATION**

The pump is now ready to be returned to service. It should be reinstalled as described in the installation section.

### **SPARE PARTS**

#### **RECOMMENDED SPARE PARTS – STANDARD OSD PUMP**

The decision on what spare parts to stock varies greatly depending on many factors such as the criticality of the application, the time required to buy and receive new spares, the erosive/corrosive nature of the application, and the cost of the spare part. Figures 16, 17 & 18 give the parts list for a typical FP-REF & FP-REI pumps.

#### **HOW TO ORDER SPARE PARTS**

Spare parts can be ordered from the local American-Marsh Sales Engineer, or from the American-Marsh Distributor or Representative. The pump size and type can be found on the name plate on the bearing housing. See Figure 3. Please provide the item number, description, and alloy for the part(s) to be ordered.

To make parts ordering easy, American-Marsh has created a catalog titled "American-Marsh Pump Parts Catalog." A copy of this book can be obtained from the local American-Marsh Sales Engineer or Distributor/Representative.

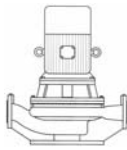
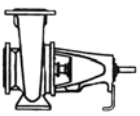
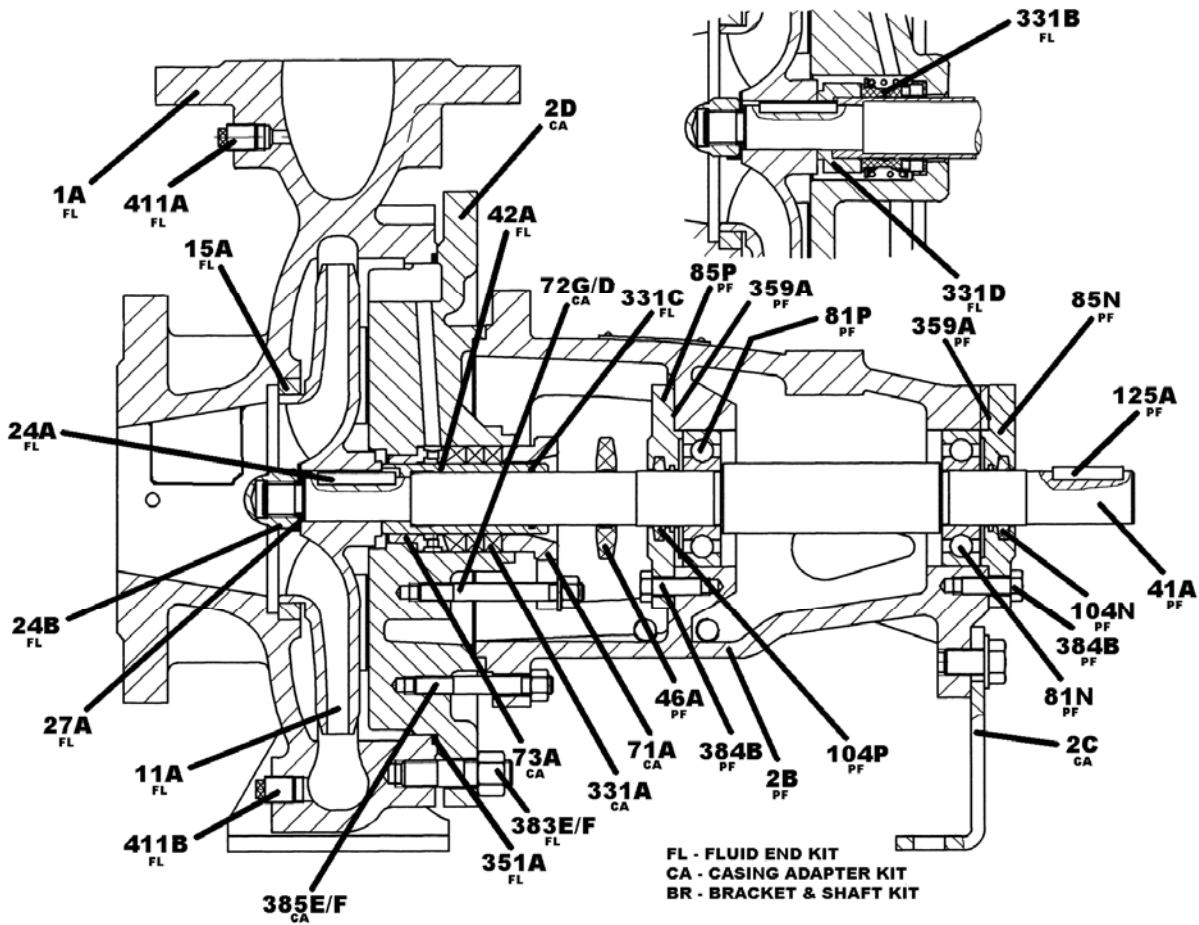

FIGURE 16 – FP-REF Sectional Drawing



Item Number	Item Description	Num. Req.
1A	Casing	1
2B	Power Frame	1
2C	Foot, Power Frame	1
2D	Casing Adapter	1
11A	Impeller	1
15A	Case Wear Ring, Front	1
15B	Case Wear Ring, Rear	Varies
24A	Impeller Key	1
24B	Impeller Nut	1
27A	Impeller Washer	1
41A	Shaft	1
42A	Shaft Sleeve	1
46A	Water Slinger	1
71A	Stuffing Box Gland	1
72G/D	Hinge Bolt & Nut	2
73A	Lantern Ring	1
81N	Outboard Bearing, Thrust	1

Item Number	Item Description	Num. Req.
81P	Inboard Bearing, Radial	1
85N	Outboard Bearing Cap	1
85P	Inboard Bearing Cap	1
104N	Outboard Lip Seal	1
104P	Inboard Lip Seal	1
125A	Coupling Key	1
331A	Packing	1 Set
331B	Mechanical Seal	1
331C	Shaft Sleeve O-Ring	1
331D	Mechanical Seal Locking Collar	1
351A	Casing Gasket	1
359A	Bearing Housing Gasket	2
383E/F	Casing Stud & Nut	Varies
385E/F	Bearing Housing Stud & Nut	Varies
384B	Bearing Cap Capscrew	1
411A	Plug, Vent	1
411B	Plug, Drain	1

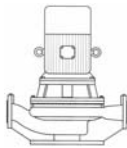
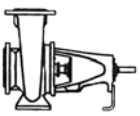
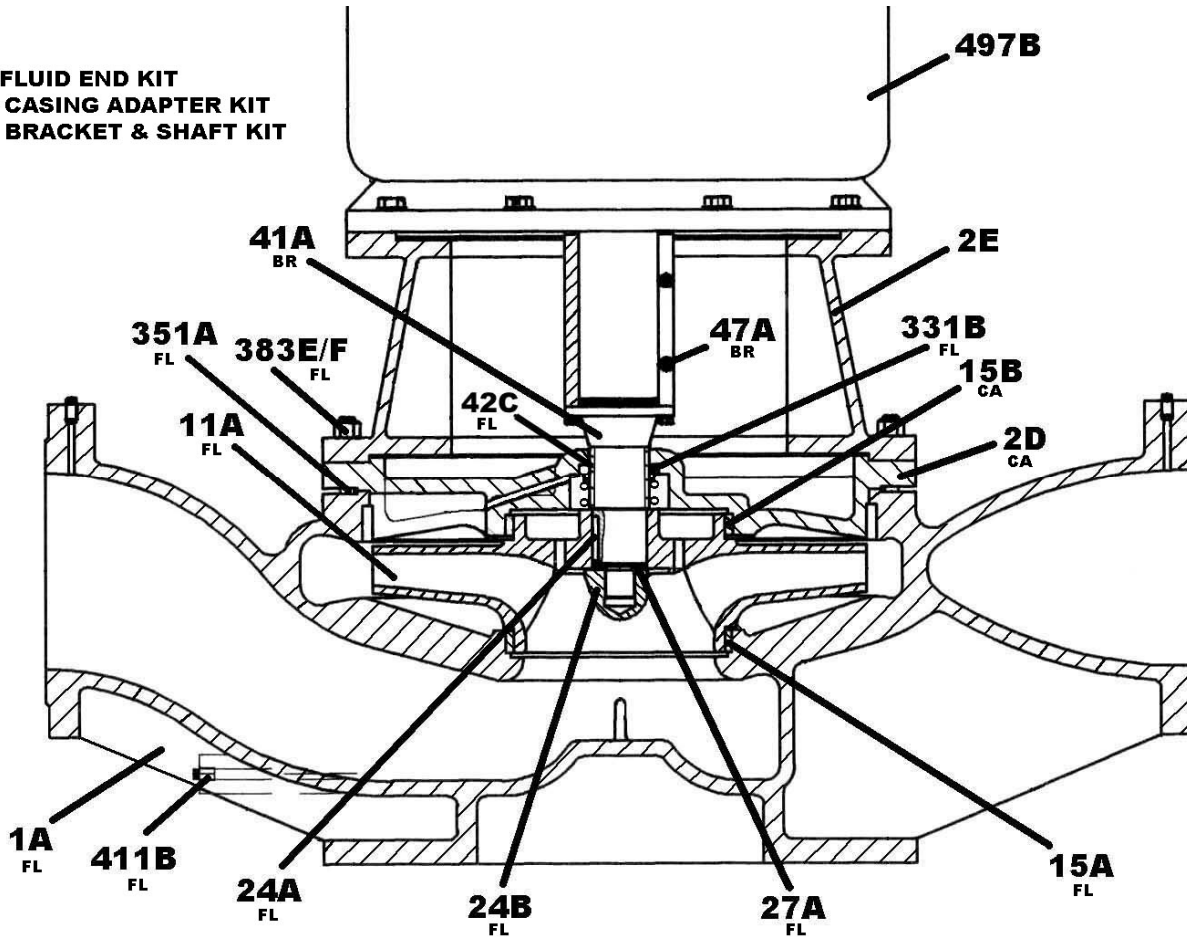

FIGURE 18 – FP-REI Sectional Drawing

FL - FLUID END KIT  
 CA - CASING ADAPTER KIT  
 BR - BRACKET & SHAFT KIT



Item Number	Item Description	Num. Req.
1A	Casing	1
2D	Casing Adapter	1
2E	Motor Bracket	1
11A	Impeller	1
15A	Case Wear Ring, Front	1
15B	Case Wear Ring, Rear	Varies
24A	Impeller Key	1
24B	Impeller Nut	1
27A	Impeller Washer	1

Item Number	Item Description	Num. Req.
41A	Shaft	1
42C	Shaft Sleeve	1
47A	Shaft Set Screw	Varies
331B	Mechanical Seal	1
351A	Casing Gasket	1
383E/F	Casing Stud & Nut	Varies
411B	Plug, Drain	1
497B	C-Face Motor	1

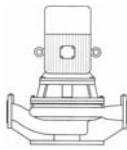
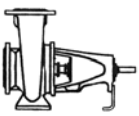

## APPENDIX A

### CRITICAL MEASUREMENTS AND TOLERANCES FOR MAXIMIZING MTBPM

#### PARAMETERS THAT SHOULD BE CHECKED BY USERS

American-Marsh recommends that the user check the following measurements and tolerances whenever pump maintenance is performed. Each of these measurements is described in more detail on the following pages.

Topic	Suggested By Major Seal Vendors in (mm)	Suggested And/Or Provided By AMP in (mm)
Shaft		
Diameter tolerance, under bearings		0.0002 (0.005)
Impeller		
Balance		See Note 1
Bearing Housing		
Diameter (ID) tolerance at bearings		0.0005 (0.013)
Power End Assembly		
Shaft Runout	0.001 (0.03)	0.001 (0.03)
Shaft Sleeve Runout	0.002 (0.05)	0.002 (0.05)
Radial Deflection - Static	0.003 (0.076)	0.002 (0.05)
Shaft Endplay	0.002 (0.05)	0.002 (0.05)
Seal Chamber		
Face Squareness to Shaft	0.001 (0.03)	0.003 (0.08)
Register Concentricity	0.005 (0.13)	0.005 (0.13)
Complete Pump		
Shaft movement caused by pipe strain	0.002 (0.05)	0.002 (0.05)
Alignment		See Note 2
Vibration at bearing housing		See Note 3

FIGURE 19 - Measurements

N.S. = Not specified

**Note 1:** The maximum values of acceptable unbalance are: 1800 rpm: 0.021 oz•in/lb (1500 rpm: 40 g•mm/kg) of mass; 3600 rpm: 0.011 oz•in/lb (2900 rpm: 20 g•mm/kg) of mass. American-Marsh performs a single plane spin balance on most impellers. All balancing, whether single or two plane, is performed to the ISO 1940 Grade 6.3 tolerance criteria.

**Note 2:** American-Marsh recommends that the pump and motor shafts be aligned to within 0.002 in (0.05 mm) parallel F.I.M. (Full Indicator Movement) and 0.0005 in/in (0.0005 mm/mm) angular F.I.M. Closer alignment will extend MTBPM. For a detailed discussion of this subject see the Alignment section of this IOM.

**Note 3:** American-Marsh recommends the following peak velocities, in in/s (mm/second): 25A/25B & 35 = 0.1 (2.5), 45 & 55 = 0.15 (3.8), 60 & 70 = 0.25 (6.3).

#### ADDITIONAL PARAMETERS CHECKS BY AMERICAN-MARSH

The parameters listed below are somewhat more difficult to measure and/or may require specialized equipment. For this reason, they are not typically checked by our customers, although they are monitored by American-Marsh during the manufacturing and/or design process. These parameters are described at the end of this appendix.

Topic	Suggested By Major Seal Vendors	Suggested And/Or Provided By AMP
Shaft - Maximum roughness at seal chamber		16µin (0.40 µm)
Bearing Housing - Bore Concentricity		0.001 in (0.025 mm)
Complete Pump – Dynamic Shaft Deflection*	0.002 in (0.05 mm)	0.002 in (0.05 mm)

FIGURE 20 – Specialized Measurements

\*The ASME standard recommends 0.005 in (0.13 mm) max deflection at the impeller, while American-Marsh provides 0.002 in (0.05 mm) max deflection at the mechanical seal. The two recommendations are essentially equivalent.

#### IMPELLER BALANCING

Shaft whip is deflection where the centerline of the impeller is moving around the true axis of the pump. It is not caused by hydraulic force but rather by an imbalance with the rotating element. Shaft whip is very hard on the mechanical seal because the faces must flex with each revolution in order to maintain contact. To minimize shaft whip it is imperative that the impeller is balanced. All impellers manufactured by American-Marsh are balanced after they are trimmed. If for any reason, a customer trims an impeller, it must be re-balanced.

The maximum values of acceptable unbalance are:  
1800 rpm: 0.021 oz•in/lb (1500 rpm: 40 g•mm/kg) of mass  
3600 rpm: 0.011 oz•in/lb (2900 rpm: 20 g•mm/kg) of mass  
The OD of the bearings should also be checked and should conform to the min/max values given above.

#### POWER END ASSEMBLY

##### Shaft/Shaft Sleeve Runout

Shaft runout is the amount the shaft is “out of true” when rotated in the pump. It is measured by attaching a dial indicator to a stationary part of the pump so that its contact point indicates the radial movement of the shaft surface as the shaft is rotated slowly. If a shaft sleeve is used then shaft sleeve runout must be checked. It is analogous to shaft runout.

Measurement of shaft runout/ shaft sleeve runout will disclose any out of roundness of the shaft, any

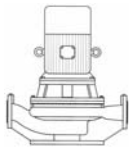
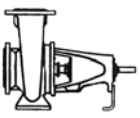

eccentricity between the shaft and the sleeve, any permanent bend in the shaft, and/or any eccentricity in the way the shaft or bearings are mounted in the bearing housing.

Shaft runout can shorten the life of the bearings and the mechanical seal. The following diagram shows how to measure shaft/shaft sleeve runout. Note that both ends need to be checked. The runout should be 0.001 in (0.025 mm) FIM or less.

### Radial Deflection – Static

Radial movement of the shaft can be caused by a loose fit between the shaft and the bearing and/or the bearing and the housing. This movement is measured by attempting to displace the shaft vertically by applying an upward force of approximately ten pounds to the impeller end of the shaft. While applying this force, the movement of an indicator is observed as shown in the following diagram. The movement should be checked at a point as near as possible to the location of the seal faces. A movement of more than 0.002 in (0.05 mm) is not acceptable.

### Shaft Endplay

The maximum amount of axial shaft movement, or endplay, on an American-Marsh pump should be 0.001 in (0.03 mm) and is measured as shown below. Observe indicator movement while tapping the shaft from each end in turn with a soft mallet. Shaft endplay can cause several problems. It can cause fretting or wear at the point of contact between the shaft and the secondary sealing element. It can also cause seal overloading or underloading and possibly chipping of the seal faces. It can also cause the faces to separate if significant axial vibration occurs.

### SEAL CHAMBER

#### Face Squareness to Shaft

Also referred to as “Seal Chamber Face Run-Out.” This runout occurs when the seal chamber face is not perpendicular to the shaft axis. This will cause the gland to cock, which causes the stationary seat to be cocked, which causes the seal to wobble. This runout should be less than 0.003 in (0.08 mm).

#### Register Concentricity

An eccentric seal chamber bore or gland register can interfere with the piloting and centering of the seal components and alter the hydraulic loading of the seal faces, resulting in reduction of seal life and performance. The seal chamber register concentricity should be less than 0.005 in (0.13 mm).

### COMPLETE PUMP

#### Shaft Movement Caused by Pipe Strain

Pipe strain is any force put on the pump casing by the piping. Pipe strain should be measured as shown below. Install the indicators as shown before attaching the piping to the pump. The suction and discharge flanges should now be bolted to the piping separately while continuously observing the indicators. Indicator movement should not exceed 0.002 in (0.05 mm).

#### Alignment

Misalignment of the pump and motor shafts can cause the following problems:

- Failure of the mechanical seal
- Failure of the motor and/or pump bearings
- Failure of the coupling
- Excessive vibration/noise

The schematics below show the technique for a typical rim and face alignment using a dial indicator. It is important that this alignment be done after the flanges are loaded, and at typical operating temperatures. If proper alignment cannot be maintained a C-flange motor adapter and/or stilt/spring mounting should be considered.

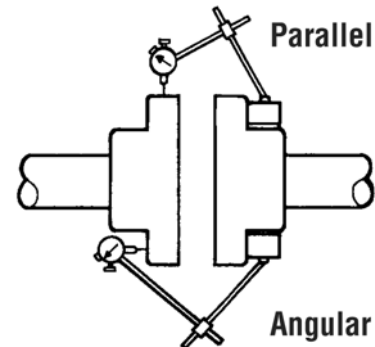

FIGURE 21 – Alignment

Many companies today are using laser alignment which is a more sophisticated and accurate technique. With this method a laser and sensor measure misalignment. This is fed to a computer with a graphic display which shows the required adjustment for each of the motor feet.

#### Vibration Analysis

Vibration Analysis is a type of condition monitoring where a pump’s vibration “signature” is monitored on a regular, periodic basis. The primary goal of vibration analysis is extension on MTBPM. By using this tool American-Marsh can often determine not only the existence of a problem before it becomes serious, but also the root cause and possible the solution. Modern vibration analysis equipment not only detects if a vibration problem exists, but can also suggest the cause of the problem. On a centrifugal pump, these causes



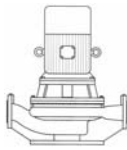
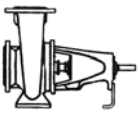

can include the following: unbalance, misalignment, defective bearings, resonance, hydraulic forces, cavitation, and recirculation. Once identified, the problem can be corrected, leading to increased MTBPM for the pump.

American-Marsh does not make vibration analysis equipment, however American-Marsh strongly urges customers to work with an equipment supplier or consultant to establish an on-going vibration analysis program. The ASME standard for vibration at the bearing housing is 0.25 inches/second (6.35 mm/sec) peak velocity or 0.0025 inches (0.064 mm) peak-to-peak displacement. American-Marsh recommends the following peak velocities:

25A/25B & 35	0.1 in/s (2.5 mm/s)
45 & 55	0.15 in/s (3.8 mm/s)
60 & 70	0.25 in/s (6.4 mm/s)

for best practice of a properly installed and operated pump.

### **SPECIAL PARAMETERS CHECKED BY AMERICAN-MASH**

#### **SHAFT – MAXIMUM ROUGHNESS AT SEAL CHAMBER**

American-Marsh shafts do not exceed 16  $\mu$ in (0.4  $\mu$ m) at these areas. American-Marsh audits smoothness by using a profilometer surface finish gauge.

#### **BEARING HOUSING – BORE CONCENTRICITY**

If the bore for holding the bearing is eccentric, the bearing will be shifted off center. This will contribute to shaft runout. American-Marsh measures this concentricity by using computerized measuring equipment. The concentricity should not exceed 0.001 in (0.03 mm).

#### **COMPLETE PUMP – DYNAMIC SHAFT DEFLECTION**

In regards to pump operation, a very important factor for maximizing pump MTBPM is the avoidance of off-design pump operation. In order to maximize the life of the seal and bearings, a process pump should be run as close as possible to its Best Efficiency Point (BEP).

Dynamic shaft deflection is a deflection of the shaft caused by unbalanced hydraulic forces acting on the impeller. Dynamic shaft deflection will change as the pump is operated on various points along the curve. When the pump is operated at BEP, the shaft deflection is zero. This deflection is very difficult to measure.

At a given point on the curve, the shaft deflection is constant and is constantly in the same direction. The centerline of the impeller, though bent from parallel, does not move. For this reason, in many cases, shaft deflection is not particularly hard on mechanical seals. It is, however, hard on bearings, since the force which causes shaft deflection can be a tremendous load on them. The amount of deflection depends on three factors: how the shaft is supported, the strength of the shaft and the amount of unbalanced hydraulic force experienced by the shaft/impeller. If there seems to be a shaft deflection problem, refer to the American-Marsh Pump Engineering Manual for a detailed discussion on how to calculate deflection.



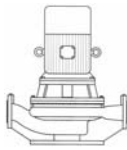
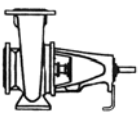

## APPENDIX B

### AMERICAN-MARSH REF MAINTENANCE INSTRUCTIONS BEARING HOUSING OIL SEALS (LABYRINTH TYPE) INPRO/SEAL® VBXX BEARING ISOLATORS

#### INTRODUCTION

American-Marsh Pumps provides pumps fitted with a variety of labyrinth oil seals. While these instructions are written specifically for the Inpro/Seal VBXX labyrinth, they also apply to seals of other manufacturers. Specific installation instructions included with the seal, regardless of manufacturer, should be observed.

The Inpro “VBXX” Bearing Isolator is a labyrinth type seal which isolates the bearings from the environment (uncontaminated), and retains the oil in the bearing housing. The bearing isolator consists of a rotor and a stator. The rotor revolves with the shaft, driven by a close fitted drive ring that rotates with the shaft. The stator is a stationary component that fits into the housing bore with a press fit (nominal 0.002 in (0.05 mm) interference) and with an “O” ring gasket seal. The two pieces are assembled as a single unit, and are axially locked together by an “O” ring. There is no mechanical contact between the rotor and stator when the isolator is running.

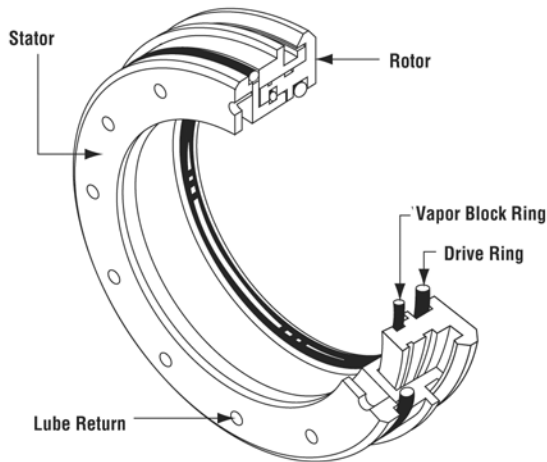

**FIGURE 22 – Bearing Isolator**

The VBXX is not intended to be separated from the bearing housing/adapter/carrier unless being replaced.

1. If the VBXX is removed from the housing, for any reason, it must be replaced with a new VBXX to ensure a perfect seal with the housing bore.

2. Repair or replacement of the seals is only necessary when excessive oil leakage is evident. However, if for any other reason, the bearing housing is to be disassembled or the pump shaft removed, it is recommended that the rotor “O” rings (which seal on the shaft) be replaced. Spare or replacement “O” rings may be obtained from “Inpro” distributors.

The “Inpro” VBXX bearing isolator is a one piece assembly. The rotor must not pull out of the stator. If the rotor can be removed, the complete seal assembly must be replaced.

3. If the bearing housing or bearing carrier with bronze VBXX seals is washed or cleaned using a caustic type bath, the bronze material may discolor (turn black). If this happens, the complete seal assembly must be replaced.
 

**Note:** This may occur if the housing is left in a caustic bath over a long period of time (more than 8 hours).

4. To remove the VBXX bearing isolator:
  - A. Remove the pump shaft as described in the pump disassembly instructions.
  - B. From the inside of the bearing housing or bearing carrier, place a bar (made from a soft material such as wood or plastic) against the inside face of the seal. Push the seal out by tapping the bar with a soft mallet or an arbor press.

5. To install a new VBXX bearing isolator, in the impeller end of the bearing housing/adapter:
  - A. Position the impeller end (inboard) seal in the bore of the adapter or bearing housing with the **single expulsion port at the 6 o’clock position**, (carefully keep aligned with the bore).
  - B. The seal stator O.D. press fits into the bore. Use an arbor press. Place a block or bar (large enough to protect the rotor flange) between the arbor press ram and seal face. Press the seal down into the bore stopping at the shoulder on the stator O.D.

The elastomer “O” ring acts as a gasket to ensure damming up of small imperfections in the housing bore. The “O” ring is designed to be compressed to the point of overfilling its groove. The overfilled material is sheared off during assembly. Remove any sheared “O” ring material which may extrude from the bore.

6. To install a new VBXX bearing isolator in the drive end (outboard) side of the bearing carrier:
  - A. Position the outboard seal in the bore of the bearing cap (no orientation of the

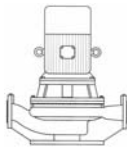
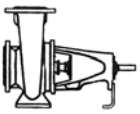

multiple expulsion ports is necessary) and carefully keep aligned with the bore. If the outboard seal has only one expulsion port, that port must be oriented at the 6 o'clock position.

Because the bearing carrier rotates for impeller adjustment, take the necessary steps to ensure the expulsion port is oriented at 6 o'clock when the pump is installed and operating.

B. The seal stator O.D. press fits into the bore. Use an arbor press. Place a block or bar (large enough to protect the rotor flange) between the arbor press ram and seal face. Press the seal down into the bore stopping at the shoulder on the stator O.D. Remove any sheared o-ring material which may extrude from the bore.

7. Assemble the bearing carrier/VBXX bearing isolator on to the shaft:
  - A. Using sand paper, remove burrs and break any sharp edges off the keyway at end of the shaft.
  - B. It is important to prevent the corners of the keyway from cutting the "O" rings during assembly. This can be accomplished with the use of a half key or a thin flexible sleeve. Lightly lubricate the shaft and slide the bearing cap on to the shaft, pushing on the VBXX rotor, until the bearing is seated.
  - C. Check the position of the rotor (make sure rotor and stator have not separated) and seat the rotor snugly into the stator by hand.